



सत्यमेव जयते

Ministry of Housing and Urban Affairs
Government of India

FAECAL SLUDGE TREATMENT SYSTEMS DESIGN MODULE

PART B: LEARNING NOTES

TITLE

Faecal Sludge Treatment Systems: Design Module (Part B: Learning Notes)

PUBLISHER

National Institute of Urban Affairs, New Delhi

RESEARCH PROJECT

Sanitation Capacity building Platform (SCBP)

GRAPHIC DESIGN

Deep Pahwa, Devender Singh Rawat, Bhavnesh Bhanot, Preeti Shukla

Copyright © NIUA (2021) Second Edition

Year of Publishing: 2021

CONTENT

The module has been developed with the collaborative effort of NFSSMA partner organisations under Training Module Review Committee (TMRC) anchored by NIUA.

Editor	Authors	Contributor and reviewer
National Institute of Urban Affairs (NIUA)	National Institute of Urban Affairs Ecosan Services Foundation	National Faecal Sludge and Septage Management Alliance (NFSSMA)

DISCLAIMER

While every effort has been made to ensure the correctness of data/information used in this training module, neither the authors nor NIUA accept any legal liability for the accuracy or inferences drawn from the material contained therein or for any consequences arising from the use of this material. No part of this module may be reproduced in any form (electronic or mechanical) without proper acknowledgement.



Copyright 2021 National Institute of Urban Affairs. This work is licensed under Attribution-ShareAlike 4.0 International. To view a copy of this license, visit <http://creativecommons.org/licenses/by-sa/4.0/>

CONTACT

National Institute of Urban Affairs
1st and 2nd floor Core 4B,
India Habitat Centre,
Lodhi Road, New Delhi 110003, India
Website: www.niua.org, scbp.niua.org
E-Mail: scbp@niua.org



सत्यमेव जयते

Ministry of Housing and Urban Affairs
Government of India

FAECAL SLUDGE TREATMENT SYSTEMS DESIGN MODULE

PART B: LEARNING NOTES

Collaborative Effort Under Training Module Review Committee (TMRC)



दुर्गा शंकर मिश्र
सचिव
Durga Shanker Mishra
Secretary



भारत सरकार
आवासन और शहरी कार्य मंत्रालय
निर्माण भवन, नई दिल्ली-110011
Government of India
Ministry of Housing and Urban Affairs
Nirman Bhawan, New Delhi-110011

FOREWORD

Government of India launched Swachh Bharat Mission-Urban on 2nd October, 2014 to make country fully clean in five years and three other flagship Missions viz. Atal Mission for Rejuvenation and Urban Transformation (AMRUT), Smart City Mission (SCM) and Pradhan Mantri Awas Yojana-Urban (PMAY-U) were also launched on 25th June, 2015. These Missions aimed to promote sustainable and inclusive cities that provide core infrastructure and give a decent quality of life to its citizens, a green and clean environment and application of 'Smart' Solutions to make optimum utilization of resources.

Indian cities are faced with the twin challenges of managing their water demand and reducing waste water footprint. A paradigm shift is needed in favor of decentralized solutions for treatment of waste water and its reuse, promoting water harvesting and protecting our ecology. Several Indian cities are taking concrete initiatives to address this challenge. Success of achieving Open Defecation Free cities under Swachh Bharat Mission, has provided impetus for addressing safe treatment and disposal of septage waste.

National Faecal Sludge and Septage Management Policy-2017 of Govt of India, provided the policy framework for a paradigm shift in favor of decentralized and non sewerage sanitation systems for urban India. Seventeen States have adopted the National FSSM Policy and put in place their own State specific FSSM Policy. More than 440 towns across 10 states are installing decentralized septage treatment plants.

I am happy to share this set of 3 Training Modules (Orientation Module, Technology & Financing Module and Septage Treatment Systems Design Module) prepared by the National Institute of Urban Affairs (NIUA) and the National Faecal Sludge and Septage Management Alliance that will be useful for Urban Local Bodies officials and all para-statal technical agencies in planning and designing decentralized solutions. I hope the National and State level nodal training institutes of MoHUA and all other Urban Resource Centres, Universities, Colleges and autonomous bodies will find them useful for imparting conceptual and practical skills trainings to address the challenges of waste water and septage management.

These modules are made available on the **NIUA website: scbp.niua.org** in downloadable PDF format for wide range and dissemination.

(Durga Shanker Mishra)

New Delhi
02 October, 2019



Acknowledgements

Increasing urbanization of India is putting significant pressure on the available water resources and the safe disposal of waste water. Most cities are facing increasing water stress and are breaching the limits to accessing drinking water from ground water, rivers and water bodies.

A paradigm shift is needed in the urban water and waste water sector, to move away from supply side to demand management and reducing the waste water footprint of cities. Septage management is one critical component of the urban sanitation challenge. With a grant from Gates Foundation, NIUA has rolled out a Sanitation Capacity Building Platform. Over the past 4 years, NIUA has promoted decentralized and non sewerred sanitation through capacity building, technical assistance, research and policy support to states and urban local bodies.

As member of the National Faecal Sludge and Septage Management Alliance(NFSSMA), NIUA has focused on capacity building of urban local body officials and engineers of para state technical agencies across 10 states of India. NIUA supported 8 nodal national training institutes of AMRUT for delivery of trainings and partnered with 9 universities to integrate concepts and technologies in their curriculum. NIUA supported the states of UP, Rajasthan and is currently working with Uttarakhand for appropriate urban sanitation solutions.

Through a collaborative engagement of the Training Modules Review Committee(TMRC) of NFSSM Alliance, anchored by NIUA, all training content developed so far on septage management, has been strategically revised updated into a 3 set learning Modules on Faecal Sludge and Septage Management :

- **One Day Orientation Module** provides an overview of septage management challenges, technology options and planning. Appropriate for all stakeholders.
- **Two Day Technology & Financing Options for FSSM Module** and exposure visit to a Septage Treatment Plant, is an excellent induction and orientation for Elected representatives, Urban Local Bodies officials and Engineers.
- **Three Day Faecal Sludge Treatment Systems Design Module** provides an in-depth training on twin aspects of Technology choice and Designing of Treatment Plants and Co Treatment of Septage with STPs. Appropriate for technical staff of ULBs, Para state agencies, consultants and private sector.

All the three Training Modules are in 2 parts : Presentations and Learning Notes. To serve as guidance for trainees as well as trainers. All the modules are also available on the NIUA website : scbp.niua.org

The modules are produced as a collaborative engagement of NIUA and NFSSM Alliance Partner Organisations. NIUA acknowledges the support provided by Ecosan Services Foundation (ESF), Pune, CEPT University and All India Institute of Local Self Government (AIILSG), Mumbai for developing the content for various modules. We acknowledge the support provided by Bill & Melinda Gates Foundation.

In the coming years, these modules will be developed into more innovative module formats including e learning and gamification, and new face to face training modules. Thereby addressing the next generation of septage management challenge of urban India.

Hitesh Vaidya
Director, NIUA

About National Faecal sludge and Septage Management Alliance (NFSSMA)

The 'NFSSM Alliance' was formed with a vision to “Create an enabling environment which amplifies scaling of safe, sustainable and inclusive FSSM through knowledge, partnerships and innovative solutions by 2024”

Convened by Bill and Melinda Gates Foundation in 2016, the Alliance is a voluntary body that aims to:

- Build consensus and drive the discourse on FSSM at a policy level, and
- Promote peer learning among members to achieve synergies for scaled implementation and reduce duplication of efforts

The Alliance currently comprises 32 organizations across the country working towards solutions for Indian states and cities. The Alliance works in close collaboration with the Ministry of Housing and Urban Affairs (MoHUA) and several state and city governments through its members to support the progress and derive actions towards mainstreaming of FSSM at state and a national level. The NFSSM Alliance works on all aspects of city sanitation plans to regulatory and institutional frameworks across the sanitation value chain. The NFSSM Alliance working in collaboration with the Ministry of Housing and Urban Affairs has been instrumental in the passage of India's First policy on FSSM launched in 2017. This resulted in 19 out of 36 states adopting guidelines and policies for FSSM in India.

The strength of the Alliance lies in its diverse membership, which includes research institutes, academic institutions, think-tanks, quasi-government bodies, implementing organizations, data experts, consultants, and intermediaries. This enabled a multi-disciplinary view of urban sanitation, with members building on each other's expertise. The Alliance has had enormous success in championing FSSM as a viable solution to the Government of India by broadly focussing on:

1. Influencing and informing policy
2. Demonstrating success through innovation and pilots
3. Building capacities of key stakeholders across the value chain

The collaborative continues to work towards promoting the FSSM agenda through policy recommendations and sharing best practices which are inclusive, comprehensive, and have buy-in from several stakeholders in the sector

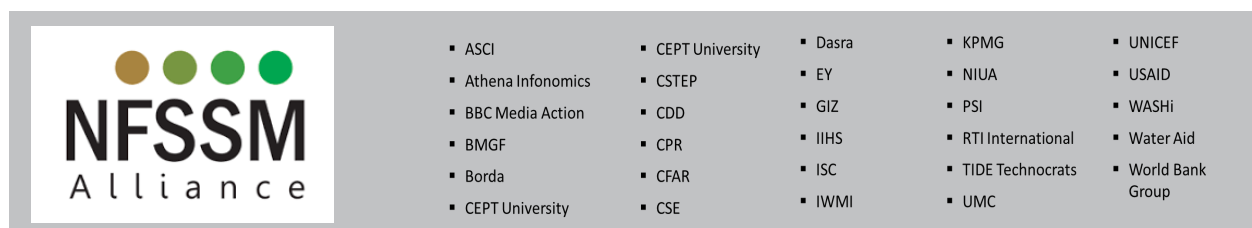

About Training Module Review Committee (TMRC)

To ensure quality control in content and delivery of trainings and capacity building efforts, a **Training Module Review Committee (TMRC)** was formed with the collaborative effort of all Alliance partners. TMRC which is **anchored by National Institute of Urban Affairs (NIUA)**, has the following broad objectives:

- Identification of priority stakeholders and accordingly training modules for Capacity Building
- Development of a Normative Framework–For Capacity Building at State Level
- Standardization of priority training modules–appropriate standardization of content with flexibility for customization based on State context
- Quality Control of Trainings–criteria for ensuring minimum quality of training content and delivery
- Strategy for measuring impact of trainings and capacity building efforts

About the Training Module

Title	Faecal Sludge and Septage Treatment: Design Module (Part B: Learning notes)
Purpose	<p>This course is designed to give the participants a detailed understanding of designing a Faecal Sludge and Septage (FSS) treatment system/plant, including conveyance and financial considerations.</p> <p>With the extension of AMRUT, the announcement of SBM-U 2.0 and AMRUT 2.0, and the recommendations of the 15th Finance Commission, this course provides participants a detailed understanding of implementing FSSM, which is a key component in these national missions.</p>
Learning objectives	<p>The module aims to convey the following learning:</p> <ul style="list-style-type: none"> • Understanding characteristics and methods of quantifying faecal sludge and septage (FSS) • Financial viability and planning of regular desludging of on-site sanitation systems such as septic tanks, at town level • Understand the FSS treatment principles, for mechanized and non-mechanized treatment technologies in different context/geographies. • Develop a know-how of different design aspects such as treatment technologies, siting and layout planning, and operation and maintenance of a treatment plant
Target audience	The module is designed for professionals, consultants and PMUs of Missions, experts, practitioners and government officials who are having an engineering background and professional experience in wastewater and septage management
Structure of the module	<p>The Module has the following two parts:</p> <p>Part A- Presentation slides: Contains the powerpoint presentations and practical exercises that trainees can refer to during the training sessions and exercise work</p> <p>Part B- Learning Note: Identifies the learning objectives and key learning outcomes that can guide trainers and trainees. Key learning outcomes are defined as specific points for each session, which need to be limited</p> <p>Part C- Workbook: This contains the exercise developed for training based on the real-life cases.</p>
Duration	The advanced technical training is proposed to be conducted in four days. It could be extended by another day depending on the size of a batch of trainees and their interest and time given for all the sessions.

LIST OF FIGURES

Figure 1: Components of sanitation system	6
Figure 2: Classification of wet sanitation systems	6
Figure 3: Picture of faecal sludge being emptied at a FSTP	7
Figure 4: Picture of Septage being emptied on to the land.	7
Figure 5: Sanitation service chain for non sewerd / hybrid sanitation	7
Figure 6: Challenges in operationalising FSSM	8
Figure 7: Picture of a person going for open defecation	9
Figure 8: A "Sweeper" being engaged to clean the community toilet	7
Figure 9: Characterisation ratios of sludge obtained from different sources.	18
Figure 10: Schematic representation of twin pits / soak pits toilets.	24
Figure 11: Schematic representation of a septic tank	24
Figure 12: Schematic representation of ABR	25
Figure 13: Schematic representation of anaerobic up-flow filter.	25
Figure 14: Picture of Sludge Gulper	30
Figure 15: Picture of Manual Diaphragm Pump	30
Figure 16: Picture of MAPET	31
Figure 17: Picture of Pit Screw Auger	32
Figure 18: Components of Vacuum Trucks	33
Figure 19: Transfer Station	35
Figure 20: Network Connected Transfer Station	36
Figure 21: Modular Transfer Station	37
Figure 22: Mobile Transfer Station	38
Figure 23: Mobile Transfer Station	38
Figure 24: Treatment Approaches In Fssm	48
Figure 25: Stages of treatment in FSS	53
Figure 26 : Decision making flow chart for selection of suitable fss treatment unit.	55
Figure 27: Layout of the Dumping Station	72
Figure 28: Design Criteria for Bar Screens (Source: Crites and Tchobanoglous,1998)	77
Figure 29: Picture of Prefabricated Manual Screens	78
Figure 30: Picture of Prefabricated Mechanical Screens	78
Figure 31: Picture of Parabolic Grit Chamber	79
Figure 32: Vortex Separators (Huber Circular Grit Trap)	79
Figure 33: Schematic Diagram of Solar Drying	89
Figure 34: Schematic Diagram of Dry Pyrolysis System	96
Figure 35: Representative Picture of Wet Pyrolysis of Hydro Thermal Carbonisation System	97
Figure 36: (A) Poor distribution of sludge over drying bed (B) Unbalanced flow from clarifier (C) Poor slopes in the channel	102

Figure 37: (A) Splash plate (B) Manhole cover with bituminous coat (C) Vent pipe installation	103
Figure 38: Manifest Form needs to be filled by desludging operator	110
Figure 39: Chain of Custody Form (Example)	113
Figure 40: Clear access to the receiving station. Easy manoeuvring of trucks pre and post decanting	119
Figure 41: No splashing / spillage during decanting	119
Figure 42: Receiving Station With Hose Pipe. Reduces The Time Taken To Decant With Minimum Spillage	119
Figure 43: Access To Water in Case of Spillage Or Cleaning Of Screens	119
Figure 44: Inclined screens Perforated tough Access for operator to rake the screens	120
Figure 45: Poorly Designed Screens	120
Figure 46: Screen Basket Without Adequate Access	120
Figure 47: Enclosed Screen With Potential Hazard of Gases	120
Figure 48: Safety rails Easy access by road / pathway Easy access to valves and pipes	120
Figure 49: Proper Layout Planning of Sludge Drying Beds	121
Figure 50: Easy Access To Valves From Outside Of The Bed	121
Figure 51: Use of Splash Plate To Reduce Erosion And Even Spreading of Sludge and Flange Joints For Easy O&M	121
Figure 52: Importance Of Length to Width Ratio, Ease Of Use of Equipment	121
Figure 53: Constructed Wetlands with access by roads	122
Figure 54: Poor Access to Tanks, Beds and Valves	122
Figure 55: Mechanical Equipments at Site (Example of Ergonomics)	123
Figure 56: Layout of Storage Yard	123
Figure 58: Adequate parking with good access by wide paved road Provision of storm water drains	123
Figure 59: Personal Protective Equipments (PPEs)	124
Figure 60: Wastewater Treatment Chain	130
Figure 62: Schematic diagram of grit chamber	131
Figure 63: Schematic diagram of Biogas Settler	132
Figure 64: Schematic diagram of Anaerobic baffled reactor	133
Figure 65: Schematic diagram of anaerobic upflow filter	134
Figure 66: Schematic diagram of UASB reactor	135
Figure 67: Schematic diagram of horizontal flow constructed wetlands	136
Figure 68: Schematic diagram of vertical flow constructed wetlands	137
Figure 69: Schematic diagram of activated sludge process	139
Figure 70: Process diagram of SBR	140
Figure 71: Schematic Diagram of Moving Bed Bio Reactor	140
Figure 72: Schematic diagram of MBR	141
Figure 73: Chlorination basin and schematic diagram of chlorine dosing and mixer	142
Figure 74: Schematic diagram of ozonation	143

LIST OF TABLES

Table 1:	Technical Details of Sludge Gulper	30
Table 2:	Technical Details of Manual Diaphragm Pump	31
Table 3:	Technical Details of MAPET	31
Table 4:	Technical Details of Screw Auger	33
Table 5:	Selection criteria for treatment mechanisms	49
Table 6:	Mechanized Dewatering: Screw Press vs Belt Filter Press based on Operation	83
Table 7:	Mechanized Dewatering: Screw Press Vs Belt Filter Press based on Performance	84
Table 8:	Operation and Maintenance Data Sheet Example	112
Table 9:	Consideration for Identification of Treatment Sites	117
Table 10:	Site Selection Criteria	118
Table 11:	Characterization and Evaluation of Treatment Site Location	118
Table 12:	Considerations of Layout Planning	119
Table 13:	Technical Details of Biogas Settlers	132
Table 14:	Technical Details of Anaerobic Baffle Reactor	133
Table 15:	Technical Details of Anaerobic Upflow Filter	134
Table 16:	Technical Details of UASB Reactor	135
Table 17:	Technical Details of Horizontal Flow Constructed Wetlands	136
Table 18:	Technical Details of Vertical Flow Constructed Wetlands	138
Table 19:	Technical Details of MBR	142
Table 20:	Technical Details of Ozonation	143

LIST OF ABBREVIATIONS

ABR	Anaerobic Baffled Reactor
AF	Anaerobic upflow Filter
BOD	Biological Oxygen Demand
CAPEX	Capital Expenditure
COD	Chemical Oxygen Demand
CT	Community Toilet
FOG	Fat Oil Grease
FSS	Faecal Sludge and Septage
FSSM	Faecal Sludge and Septage Management
FSTP	Faecal Sludge and Septage Treatment Plant
Gol	Government of India
HRT	Hydraulic Retention Time
IS	Indian Standard
LCA	Life Cycle Analysis
LCC	Life Cycle Cost
NIUA	National Institute of Urban Affairs
NGT	National Green Tribunal
ODF	Open Defecation Free
O&M	Operation and Maintenance
OPEX	Operational Expenditure
PCB	Pollution Control Board
PPE	Personal Protective Equipment
PT	Public Toilet
SBM	Swachh Bharat Mission
SCBP	Sanitation Capacity Building Platform
SeTP	Septage Treatment Plant
STP	Sewage Treatment Plant
SRT	Sludge Retention Time
TSS	Total Suspended Solids
ULB	Urban Local Body
US EPA	United States Environmental Protection Agency

AGENDA

Time Duration	Session Title
Day 1	
9.30 - 10.00 hours	Introduction of participants Ground rules Understanding the objectives of the training
10.00 - 10.45 hours	Introduction to Faecal Sludge and Septage Management and its importance and need
10.45 - 11.00 hours	Tea and Coffee Break
11:00 - 11.45 hours	Quantification of Faecal Sludge and Septage
11:45 - 12:30 hours	Characterisation of Faecal Sludge and Septage Management
12:30 - 13:30 hours	Lunch Break
13:30 - 14:15 hours	Containment Systems: Sources of Faecal Sludge and Septage
14:15 - 15:00 hours	Emptying and Conveyance of Faecal Sludge and Septage
15:00 - 15:15 hours	Tea and Coffee Break
15:15 - 16:00 hours	Exercise- Assets for emptying and conveyance of the Faecal Sludge and Septage
16:00 - 16:30 hours	Key take away Feedback Wrap up

Time Duration	Session Title
Day 2	
10:00 - 10:45 hours	Treatment Mechanism for Faecal Sludge and Septage
10:45 - 11:00 hours	Tea and Coffee Break
11:00 - 11:45 hours	Selection of Treatment components
11:45 - 12:45 hours	Formation of Faecal Sludge and Treatment Technology
12:45 - 13:30 hours	Lunch Break
13:30 - 14:15 hours	Design of Solid Liquid Separation Unit: Settling Thickening Tank
14:15 - 15:00 hours	Design of Stabilization Unit: Anaerobic Digester
15:00 - 15:15 hours	Tea and Coffee Break
15:15 - 16:00 hours	Design of Dewatering Unit: Unplanted Drying Bed
16:00 - 16:30 hours	Key take away Feedback Wrap up

Time Duration	Session Title
Day 3	
10:00 - 11:00 hours	Faecal Sludge and Septage Receiving Station
11:00 - 11:15 hours	Tea and Coffee Break
11:15 - 12:00 hours	Preliminary Treatment: Screening and Grit Removal Unit
12:00 - 13:00 hours	Mechanised Dewatering Unit: Screw Press, Belt Press
13:00 - 14:00 hours	Lunch Break
14:00 - 14:45 hours	Mechanised Drying Unit
14:45 - 15:30 hours	Mechanised Thermal Unit
15:30 - 15:45 hours	Tea and Coffee Break
15:45 - 16:30 hours	Construction, Quality control and Commissioning of a Faecal Sludge and Septage Treatment Plant
16:00 - 16:30 hours	Key take away Feedback Wrap up

Time Duration	Session Title
Day 4	
10:00 - 11:00 hours	Operation and Maintenance at a Faecal Sludge and Septage Treatment Plant
11:00 - 11:15 hours	Tea and Coffee Break
11.15 - 13.00 hours	Faecal Sludge Treatment Plant: Site identification, Components of an FSTP, Layout planning
13:00 - 14:00 hours	Lunch Break
14.00 - 14.45 hours	Liquid Treatment Systems and their suitability
14.45 - 15.30 hours	Financial aspects in FSSM
15:30 - 15:45 hours	Tea and Coffee Break
15.45 - 16.30 hours	Exercise on financial calculations for FSTP
16:00 - 16:30 hours	Key take away Feedback Wrap up



Contents

Session 1: Introduction to Operationalising Faecal Sludge & Septage Management	1
Session 2: Quantification of Faecal Sludge & Septage	11
Session 3: Characterization of Faecal Sludge & Septage	17
Session 4: Containment Systems: Sources of Faecal Sludge & Septage	23
Session 5: Emptying & Conveyance of Faecal Sludge & Septage	29
Session 6: Treatment Mechanism for Faecal Sludge & Septage	43
Session 7: Selection of Faecal Sludge & Septage Treatment Mechanisms	47
Session 8: Formation of Faecal Sludge & Septage Treatment Technologies	53
Session 9: Designing of Solid Liquid Separation Unit: Settling Thickening Tank	59
Session 10: Designing of Stabilization Unit: Anaerobic Digester	63
Session 11: Designing of Dewatering Unit: Unplanted Drying Bed	67
Session 12: Faecal Sludge & Septage Receiving Station	71
Session 13: Preliminary Treatment of Faecal Sludge & Septage	77
Session 14: Mechanized Dewatering Units	83
Session 15: Mechanized Drying Units	89
Session 16: Mechanized Thermal Treatment	95
Session 17: Construction of Faecal Sludge & Septage Treatment Plant	101
Session 18: O & M of Faecal Sludge & Septage Treatment Plant	109
Session 19: Siting, Layout Planning & Safety Planning of Faecal Sludge & Septage Treatment Plant	117
Session 20: Liquid Effluent Treatment of Faecal Sludge & Septage Treatment Plant	129
Session 21: Financial Aspects of Faecal Sludge & Septage Management	149



Session

01

Introduction to Operationalising Faecal Sludge & Septage Management

1. Session objectives

- To Understand the necessity of focussing on Non Sewered Sanitation in fastly urbanizing India
- To know how GoI, is advocating non sewerer sanitation through FSSM
- To understand the importance of FSSM in non sewerer sanitation and challenges faced by ULBs to operationalize FSSM

2. Session plan

Duration 45 -minutes

Activity	Time	Material/Method
Urbanization and sanitation	5 min	Powerpoint presentation and discussions
National program and policies and act	8 min	Powerpoint presentation and video
Introduction to FSSM	12 min	Powerpoint presentation
Needs and challenges in FSSM	15 min	Powerpoint presentation and discussions

3. Key facts

- Development of sanitation infrastructure in a fast urbanizing country like India is quite a challenge.
- Government of India (GoI) has released appropriate policies and acts for operationalising FSSM.
- Understanding and choosing an appropriate sanitation system is very important for disrupting the faecal oral transmission of diseases.
- Challenges in FSSM are relatively easier to tackle as compared to the one in sewerer sanitation.

4. Learning notes

1. Urbanization and sanitation

India by 2045 is expected to have more than 50% of its population living in the urban area. Although India will have a less urban population as compared to the developed countries, it will be host to multiple cities having a population of more than 10 million persons. The pace at which these urban centers are experiencing population explosion, it is very difficult to develop and deploy infrastructure to provide basic municipal services to the residents of the cities.

Based on the census of 2011, it can be referenced that India has been struggling to improve the sanitation services such as collection and conveyance of the waste along with the treatment and reuse/disposal of the wastewater. Hence, the GoI in 2014 launched its flagship program SBM.

2. National program, policies and acts

In order to bring a stop to human activity of manual scavenging of human waste by a person, the Prohibition Act called “The Employment of Manual Scavengers and Construction of Dry Latrines” was released on June 5th, 1993. However, later it was realized that still manual scavengers are being employed to clean septic tanks and sewers in most of urban India. Hence, on September 18th, 2013, GoI released another act called “The Prohibition of Employment as Manual Scavengers and their Rehabilitation Act”.

Swachh Bharat Mission (Urban) was implemented by the Ministry of Housing & Urban Affairs. The SBM (U) had two primary components of implementation: (a) achieving 100% open

defecation free (ODF) status (with construction of 66 lakh individual household toilets and 5.08 lakh community/public toilet seats), and (b) ensuring 100% solid waste management — in all ULBs in the country, by 2nd October 2019 (extended to 31st March 2021). This was to be done through large scale citizen engagement to create a 'Jan Andolan'. The Cost of implementation was ₹ 62,009/- Crores, including GoI share of ₹ 14,600/- Crores , and State share of ₹ 4,874/- Crores. Balance funds (₹ 42,535/- Crore) were to be generated through other sources.

In the Swachh Bharat Mission 2.0, the government is trying to tap other aspects under the Swachh Bharat mission, including safe containment, transportation, disposal of faecal sludge, and septage from toilets. It will be implemented over five years ,from 2021 to 2026, with an outlay of Rs.1.41 lakh crore.

This will be a continuation of the Swachh Bharat Mission (Urban), with the following components for funding and implementation across all statutory towns, viz.

- Sustainable sanitation (construction of toilets)
- Wastewater treatment, including faecal sludge management in all ULBs with less than 1 lakh population
- Solid Waste Management
- Information, Education and Communication, and
- Capacity building

At the end of the Mission, the following outcomes are expected to be achieved:

- All statutory towns will become ODF+ certified
- All statutory towns with less than 1 lakh population will become ODF++ certified
- 50% of all statutory towns with less than 1 lakh population will become Water+ certified
- All statutory towns will be at least 3-star Garbage Free rated as per MoHUA's Star Rating Protocol for Garbage Free cities
- Bio-remediation of all legacy dumpsites

The Atal Mission for Rejuvenation and Urban Transformation (AMRUT) mission was initiated in June 2015 which aimed to provide the basic utility services (e.g. water supply, sewerage, septage management, urban transport) to households and build amenities in cities which will improve the quality of life for all. The purpose of Atal Mission for Rejuvenation and Urban Transformation (AMRUT) is to ensure that every household has access to a tap with the assured supply of water and a sewerage connection, to increase the amenity value of cities by developing greenery and well-maintained open spaces (e.g. parks) and to reduce pollution by switching to public transport or constructing facilities for non-motorized transport (e.g. walking and cycling). All these outcomes are valued by citizens, particularly women, and indicators and standards have been prescribed by the Ministry of Housing and Urban Affairs (MoHUA) in the form of Service Level Benchmarks (SLBs).

Atal Mission For Rejuvenation And Urban Transformation (AMRUT) 2.0 has been designed to provide universal coverage of water supply to all households through functional taps in all statutory towns in accordance with SDG Goal- 6.

2.68 crore is the estimated gap in urban household tap connections that is proposed to be covered under AMRUT 2.0. Likewise, an estimated gap in sewer connections/septage in 500 AMRUT cities proposed to be covered in AMRUT 2.0 is 2.64 crore. Rejuvenation of water bodies to augment sustainable fresh water supply and creating green spaces and sponge cities to reduce floods

and enhance amenity value through an Urban Aquifer Management plan are other key areas of the Mission. AMRUT 2.0 will promote circular economy of water through development of city water balance plan for each city, focusing on recycle/reuse of treated sewage, rejuvenation of water bodies and water conservation. 20% of water demand to be met by reused water with development of institutional mechanism. A Technology Sub-Mission for water is proposed to leverage latest global technologies in the field of water.

Information, Education and Communication (IEC) campaign is proposed to spread awareness among masses about conservation of water. Pey Jal Survekshan will be conducted in cities to ascertain equitable distribution of water, reuse wastewater and map water bodies with respect to quantity and quality of water through a challenge process. Mission has a reform agenda with focus on strengthening urban local bodies and water security of the cities. Major reforms are reducing non-revenue water to below 20%; recycle of treated used water to meet at least 20% of total city water demand and 40% for industrial water demand at State level; dual piping system; unlocking value and improving land use efficiency through proper master planning; improving credit rating & accessing market finance including issuance of municipal bonds and implementation Online Building Permission System under EoDB.

The Mission also seeks to promote AatmaNirbhar Bharat through encouraging Start-ups and Entrepreneurs with an aim to promote GIG economy and on-boarding of youth & women.

Salient features of the mission:

- The total outlay proposed for AMRUT 2.0 is ₹ 2,77,000 crore.
- In order to promote Public Private Partnership (PPP), it has been mandated for cities having million plus population to take up PPP projects worth a minimum of 10 percent of their total project fund allocation.
- For Union Territories, there will be 100% central funding. For North Eastern and Hill States, central funding for projects will be 90%. Central funding will be 50% for cities will less than 1 lakh population, one third for cities with 1 lakh to 10 lakh population and 25% for cities with a million plus population.
- Mission will be monitored through a technology-based platform on which beneficiary response will be monitored along with progress and output-outcome.
- Funding from Government for projects will be in three tranches of 20:40:40. Third installment onwards will be released based on outcomes achieved, and credible exclusion will be exercised while funding.

Smart City Mission was initiated in June 2015 and aimed to promote cities that provide the basic infrastructure with a view to give a decent quality of life to its citizens, a clean and sustainable environment and application of 'smart solutions'. The focus is on sustainable and inclusive development. The underlying idea is to look at compact areas, create a replicable model which will act like a light house to other aspiring cities. The core infrastructure elements in a 'Smart City' would include adequate water supply, assured electricity supply, sanitation, including solid waste management, efficient urban mobility and public transport, affordable housing, especially for the poor, robust IT connectivity and digitalization, good governance, especially e-Governance and citizen participation, sustainable environment, safety and security of citizens, particularly women, children and the elderly, and health and education.

3. Introduction to FSSM

Sanitation systems are composed of three or more components out of the five components listed below;

Figure 1: Components of sanitation system

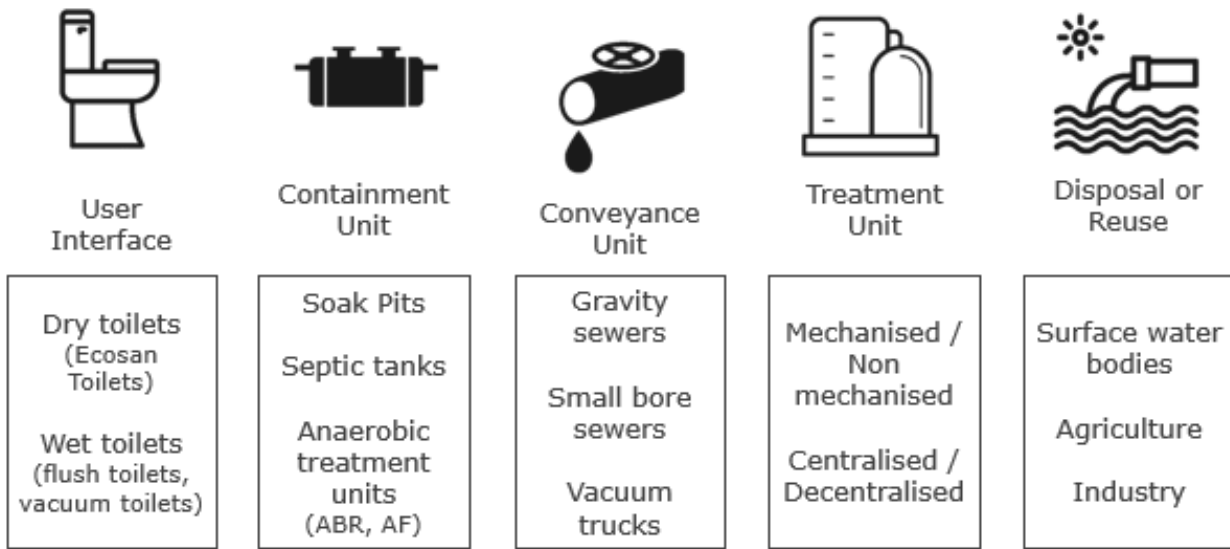
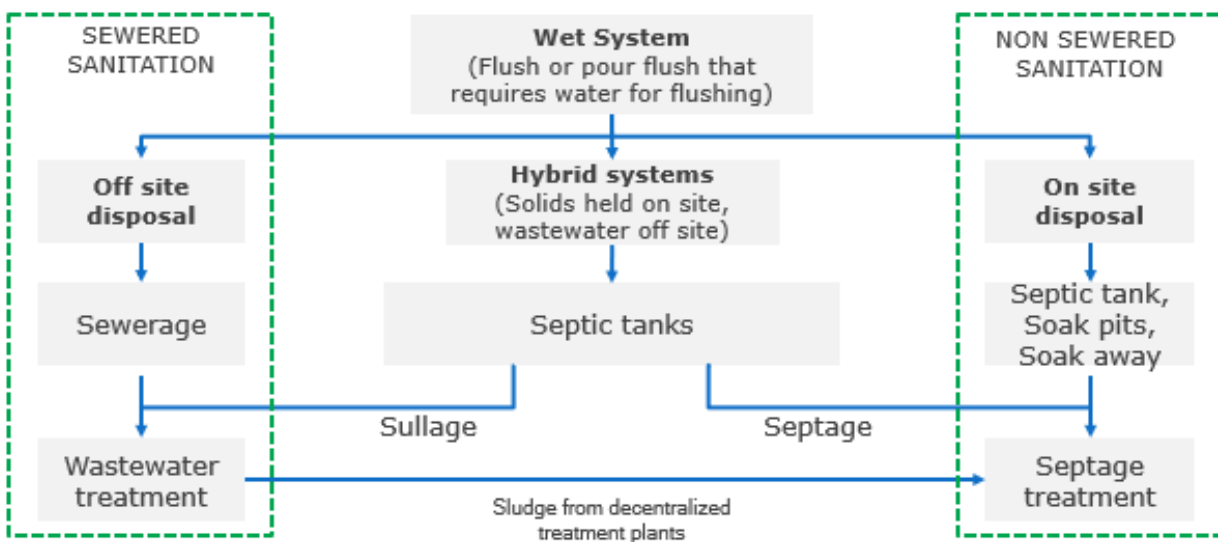

Figure 2: Classification of wet sanitation systems



Depending on the use of water for practicing hygiene activities, sanitation systems can be classified as dry and wet sanitation systems. In developing countries such as India, wet sanitation systems are found. These wet sanitation systems can be further classified into Sewered Sanitation and Non Sewered Sanitation as shown in the figure below. It is interesting to know that India is not practicing completely non sewerer sanitation in most of the cities.

All the liquid and semi liquid contents of the pits and vaults accumulating in the on-site containment units is referred to as FSS. It is significantly high TSS and TDS as compared to water.

Figure 3: Picture of faecal sludge being emptied at a FSTP



Faecal sludge is referred to the sludge obtained from the containment unit such as a line pit (insanitary latrine). It is generally fresh and yellowish in colour. This is due to the fact that these pits are quite frequently emptied. As a result, it has higher BOD and requires a higher degree of treatment.

Figure 4: Picture of Septage being emptied on to the land.



Septage is referred to the sludge obtained from the on-site containment units such as septic tanks or holding tanks. It is well digested and blackish in colour as it has undergone digestion over a period of time before being emptied. As a result of this, it has lower BOD and requires less degree of treatment.

Source: EAWAG SANDEC Training Tool: Faecal Sludge Management

A Sanitation Service Chain is referred to the activities pertaining to managing waste such as FSS. In order to manage FSS from the onsite containment systems, a ULB requires to have sanitation service chain as shown in the figure below.

Figure 5: Sanitation service chain for non sewerd / hybrid sanitation

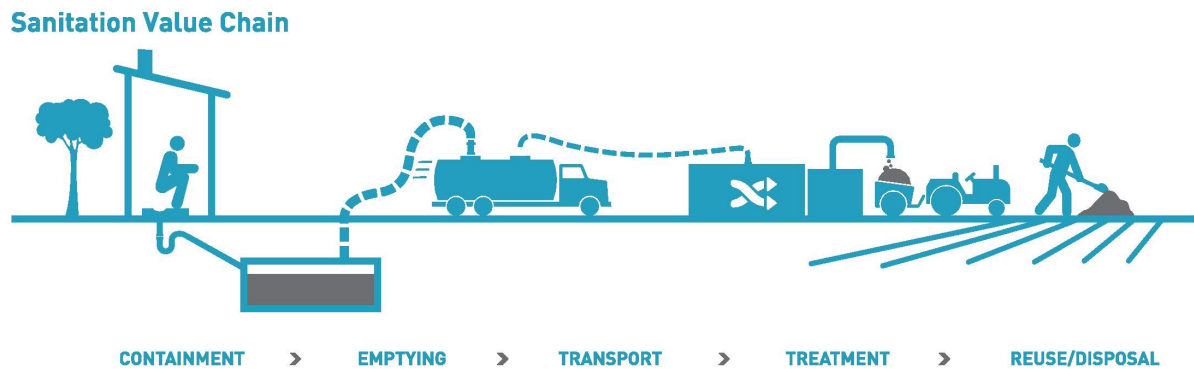

Source: Bill and Melinda Gates Foundation

In this service chain there are five components as shown in the figure- containment unit, emptying, transport, treatment and reuse/disposal. In the subsequent session we will be focussing on each of the component in detail.

4. Needs and challenges in FSSM

FSSM is needed to manage the liquid waste originating from the human waste in a better and safe way so as to eliminate faecal oral transmission of diseases. Following are the reasons why the ULBs need to focus on FSSM.

1. Insufficient infrastructure- Most of the ULBs are struggling to manage the liquid waste. There

is a lack of infrastructure such as gravity sewer network and treatment plants. Hence, until this infrastructure is set up, FSSM will help to reduce the pollution load on the water resources.

2. Health and environmental implications- Cities which are having gravity sewers are still engaging persons to clean the manholes and chambers in the sewerage network. The cleaning is required due to heavy accumulation of silt and solid waste choking the pipes. The cleaning is usually done without any specialized equipment and PPE, completely violating the Manual Scavenging Act of 2013.
3. Regulations- Government of India (GoI) have released policy and guidelines for practicing FSSM at ULB level. PCB and NGT have also become vigilant and numerous cases have been filed in the courts against the ULBs which are not managing the liquid waste appropriately.
4. Resource recovery- Faecal sludge can be digested to obtain methane gas. FSS it is known to have good calorific value (17.30 and 12.00 MJ/kg TSS respectively); hence, heat energy can be recovered from it. The dried solids from the sludge also contain nutrients and organic matter and hence it can also be used as soil conditioner to improve the characteristic of the agricultural farms.

Broader challenges faced by the ULBs in operationalising FSSM and to make it sustainable are listed in the figure below.

Figure :6 Challenges in operationalising FSSM

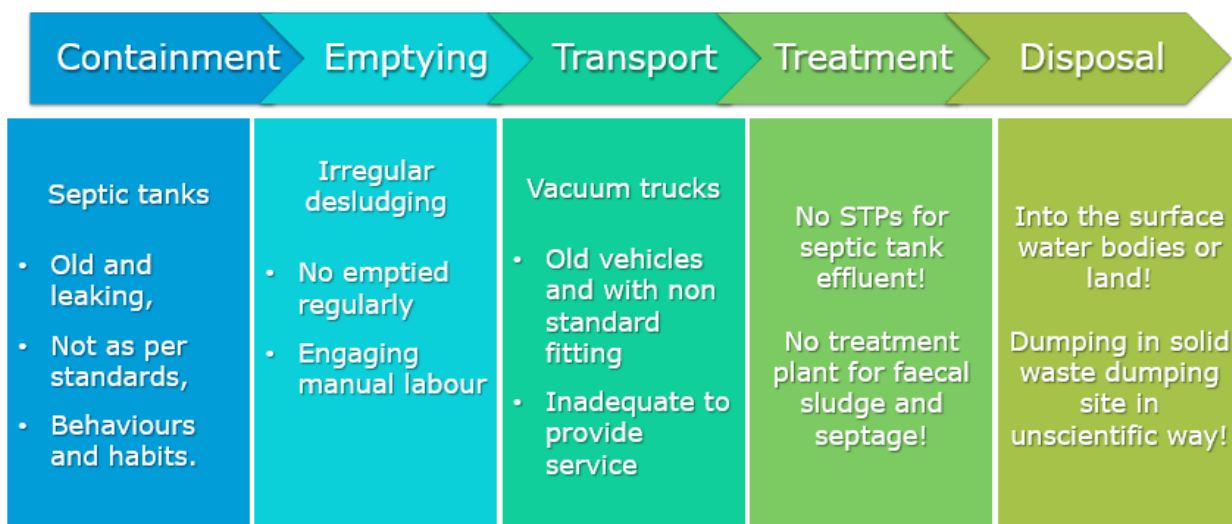

5. Notes for trainer

Images are quite powerful and can usually convey a lot as compared to the text. Hence to energize the participants to start thinking about sanitation and the following session, we begin the session with two images. The images are shown below.

Figure 7: Picture of a person going for open defecation



Source: Andrea Bruce, National Geographic

Ask the participants following questions. What does the picture depict? Can you pinpoint certain things and draw inference from the picture?

The second image is that of a “sweeper”. This image is more powerful and tells us more about the plight of the people engaged to maintain the sanitation facilities.

Figure 8: A “Sweeper” being engaged to clean the community toilet



Source: Project Samman, Quicksand

Ask the participants following questions. What does the picture depict? What kind of toilet is it? Who is the person in the picture? What is his job? Does he have the right equipment to do his job? Is his health at risk by doing this job? Will you use this toilet? If not, then why? This session also

contains a small video prepared under The Sanitation Workers Project on manual scavenging by Dalberg Advisors in 2017. The link to the video is embedded in the slide on manual scavenging act.

LINK- <https://www.youtube.com/watch?v=GGWn8G1cipA>

6. Bibliography

1. EAWAG/SANDEC (2008): (Sandec Training Tool 1.0, Module 5). Duebendorf: Swiss Federal Institute of Aquatic Science (EAWAG), Department of Water and Sanitation in Developing Countries (SANDEC) URL
2. STRANDE, L.; RONTELTAP, M.; BRDJANOVIC, D. (2014): Systems Approach for Implementation and Operation. London: IWA Publishing URL
3. Ministry of Housing and Urban Affairs, Government of India: National Policy on Faecal Sludge and Septage Management (FSSM) (2017) URL
4. Burton, F.L., Tchobanoglous, T., Tsuchihashi, R. and Stensel, H.D. (2013) Metcalf & Eddy, Inc.: Wastewater Engineering: Treatment and Resource Recovery, 5th edn, New York: McGraw-Hill Education.
5. Parkinson, J., Lüthi, C., Walther, D. (2013). Sanitation 21: A Planning Framework for Improving City-wide Sanitation Services. Published by IWA.
6. Tilley, E., Ulrich, L., Lüthi, C., Reymond, P., Zurbrügg, C. (2014). Compendium of Sanitation Systems and Technologies. Dübendorf: Swiss Federal Institute of Aquatic Science & Technology (EAWAG) 2nd revised edition.
7. US EPA (1999) Decentralized Systems Technology Fact Sheet: Septage Treatment/ Disposal (Report No. EPA 932-F-99-068), Washington, DC: EPA URL
8. Swachh Maharashtra Mission (Urban) (2016) Guidelines for Septage Management in Maharashtra, Urban Development Department, Government of Maharashtra URL

Session

02

Quantification of Faecal Sludge & Septage

1. Session objectives

- To understand the need of quantification of FSS in a town.
- To understand various methods to quantify FSS and the data required to estimate.
- To understand the different criteria affecting quantification of FSS and considerations to be taken into account while quantification.

2. Session plan

Duration- 45 minutes

Activity	Time	Material/Method
Why quantification is necessary?	5 min	Powerpoint presentation and discussions
Methods of quantification	15 min	Powerpoint presentation
Criteria and consideration for quantification	10 min	Powerpoint presentation
Discussions	15 min	Group discussions

3. Key facts

- Planning of FSSM depends on quantification of FSS
- Sludge production method – empirical and quicker method
- Sludge collection method – reliable and more robust, however is a time-consuming method
- Seasonal variation can be quite prominent depending on the local conditions and may change from town to town
- Peaking factor should be considered while quantification. This ensures that the treatment facility does not become inadequate or over loaded during its operation.

4. Learning notes

1. Why is quantification necessary?

Quantification is necessary for estimating the number of equipment required for providing the service of emptying of septic tanks and transport of the sludge to a treatment facility. It is required to estimate the equipment required to co treat the septage at STP or to define the capacity of the independent treatment facility. Quantification becomes of utmost importance when financial viability of operationalizing FSSM in a town needs to be understood.

To start with quantification of FSS to be managed, the ULB needs to decide the type of desludging to be practiced. There are two types of desludging practices- (1) on demand desludging and (2) scheduled desludging.

2. Methods of quantification

Sludge production method

Sludge production method is useful in case of scheduled desludging. This method is based on the number of people and the standard sludge production rate. This is similar to estimating the wastewater production where 80% of the water utilized by the person is taken as quantity of wastewater produced. According to the IS 2470 Code of practice for Installation of Septic Tanks (part 1: Design criteria and construction) 1985, volume of digested sludge in the septic tank is given as 0.00021 m³/cap/d. The US EPA handbook on Technology Transfer for Septage Treatment and Disposal mentions the average per capita septage generation as 230 L/cap/d. It has also been mentioned that this number is highly variable and will change depending on a number of factors discussed in the next session.

Sludge collection method

The sludge collection method needs to be adopted for quantification of FSS in case of demand desludging. In most of the cases of Indian cities, not all the waste which is generated at the household level is usually collected, be it solid or liquid. Hence, sludge collection method is much more reliable estimate of quantification of FSS in a city.

In this method structured interviews need to be conducted with important stakeholders such as desludging operators, ULB official such as sanitary inspectors and households. Depending upon the responses and statistical analysis of the data collected, inferences are drawn to arrive at the quantity of FSS to be managed in a city.

Stakeholders and Data Collection

There are 3 key stakeholders i.e. desludging operator and his ground staff, ULB officials and Households with whom we have to carry out consultations and have to collect the data. It is very important to have structured interviews with them for appropriate quantification

1) Desludging Operator and Ground Staff

- General Details – Equipment, staff, Regulatory status
- Quantity of Sludge collected – Capacity of truck, number of rotations per truck per day/month/year, Seasonal Variations, Availability of records
- IHHL, Public or Community Toilet
- Emptying frequency
- Disposal/endues – disposal sites, discharge in agricultural field? endues practices?

2) ULB Officials

- Availability of sanitation data – IHHL, CT, PT, Type of on-site containment system
- Existing Wastewater management – coverage
- Existing FSS Collection and Conveyance services – no. of operators, tariffs or tipping fee
- Regulatory Framework – Municipal Bylaws or FSSM Policy
- Treatment, Disposal/endues – disposal sites, existing wastewater treatment system, reuse practices (if any)

3) Household

- Type of toilet, on-site containment system, volume
- Emptying frequency, Emptying Tariffs, willingness to pay for improved services

Criteria and considerations for quantification

Seasonal and monthly variations need to be taken into account while quantification. Especially in cities which experience inflow of floating population (due to pilgrimage or tourism) on an annual basis needs to take into consideration the variation and peaking factor.

Peaking factor is necessary to calculate the peak load which the treatment facility might have to handle in a month. The peaking factor in case of FSS can range from 1.5 to 4

5. Notes for trainer

Originally this session does not contain any group activity. However, if time permits and depending on the type of participants, one can conduct a group activity. The group activity is pertaining to type of desludging. You can ask the group to discuss and write pros and cons of on demand and scheduled desludging along with the data required to quantify FSS in each case. A simple flip chart along with markers can be used by each group to document their discussions which can be pinned up in the training hall for viewing later.

6. Bibliography

1. STRANDE, L.; RONTELTAP, M.; BRDJANOVIC, D. (2014): Systems Approach for Implementation and Operation. London: IWA Publishing URL.
2. EAWAG/SANDEC (2008): (Sandec Training Tool 1.0, Module 5). Duebendorf: Swiss Federal Institute of Aquatic Science (EAWAG), Department of Water and Sanitation in Developing Countries (SANDEC) URL
3. Heins, U., Larmie, S. A., Strauss, M. (1998). Solids Separation and Pond Systems for the Treatment of Faecal Sludges in the Tropics. Lessons learnt and recommendations for preliminary design. SANDEC Report No. 5/98. Second Edition. Swiss Federal Institute for Environmental Science and Technology (EAWAG) and Water Research Institute (WRI), Accra/Ghana.
4. Heins, U., Larmie, S.A., Strauss, M. (1994). Sedimentation Tank Sludge Accumulation Study. EAWAG/SANDEC publications.
5. Ingallinella A.M., Sanguinetti G., Koottatep, T., Montangero, A., Strauss, M. (2002). The challenge of faecal sludge management in urban areas – strategies, regulations and treatment options. Water Science and Technology 46(10), p.285-294.

Session

03

Characterization of Faecal Sludge & Septage

1. Session objectives

- To understand the parameters which are used to characterize FSS and with a focus on solid and COD content of the FSS
- To understand how FSS differs from sewage and how to draw inference from the characterization ratios for choosing appropriate treatment mechanisms
- To understand the operational factors affecting the characteristics of the FSS

2. Session plan

Duration- 45 minutes

Activity	Time	Material/Method
Parameters for FSS characterisation	15 min	Powerpoint presentation
Comparison of sludge characteristics and characterisation ratios	20 min	Powerpoint presentation
Operational factors affecting the characteristics of sludge	10 min	Powerpoint presentation

3. Key facts

- Parameters considered for characterisation of FSS is same as that of wastewater
- FSS although similar in characteristics, is much stronger than sewage
- Characteristics of FSS change depending upon the source
- Characterisation ratio is considered while choosing the right treatment processes
- Operational factors affect the characteristics of FSS

4. Learning notes

1. Parameters for characterization of FSS

The parameters used to characterize the FSS is same as that which are used for sewage and are stated below;

- Solid concentration (TS, TSS, TVS, VSS)
- Chemical Oxygen Demand (COD)
- Biological Oxygen Demand (BOD5)
- Nutrients (TKN, NH₃-N, Total P)
- Pathogens (Faecal coliform, Helminth eggs)
- Metals

The slowly biodegradable COD content of faecal sludge is much higher than septage. Hence in order to stabilise the faecal sludge, anaerobic digestion with more retention time is required. Septage has significantly higher amount of particulate non-biodegradable COD. This means septage does not need much stabilisation and COD reduction in septage can be achieved by simply removing the suspended solids from the liquid fraction.

2. Comparison of sludge characteristics and characterization ratios

FSS is highly concentrated in all parameters when compared to sewage. It has been reported in case of some parameters it as up to 68 times more concentrated as compared to sewage.

FSS is stronger than the sewage sludge formed at STP and its characteristics is still different. However, the treatment mechanisms which are used to management of sewage sludge can be tweaked and used for management of FSS.

The characterization ratios are important and convey a lot about the constituent of liquid waste and their interdependence. The following table represents characterization ratios for sludge obtained from containment units linked to public toilet, septic tank of household and medium strength wastewater.

Figure 9: Characterisation ratios of sludge obtained from different sources.

Ratio (gm/gm)	Public toilets	Septic tanks	Medium strength wastewater
VSS:TSS	0.65-0.68	0.50-0.73	0.60-0.80
COD:BOD ₅	5.0	1.43-3.0	2.0-2.5
COD:TKN	0.10	1.2-7.8	8-12
BOD ₅ :TKN	2.2	0.84-2.6	4-6
COD:TP	109	8.0-52	35-45
BOD ₅ :TP	17	5.6-17.3	15-20

(Source: Faecal Sludge Management: System Approach and Implementation)

The percent of volatile solids to suspended solids tell us about stabilisation of the sludge. Higher the quantity of the VSS means the sludge needs stabilisation. The COD:BOD ratios tell us; how much fraction of the organic solids are easily degradable. The higher ratio indicates higher presence of difficult to digest solids. The organic content to nitrogen ratios also indicates that the organic concentrations are not sufficient for nitrogen removal by denitrification.

3. Operational factors affecting the sludge characteristics

Local conditions and operational factors which are heavily influenced by habits and behavior of people impact the FSS characteristics. Following are a few of the operational factors which had an impact on the sludge characteristics;

1. Toilet usage- inclusion and exclusion of grey water, use of additives or disposal of solid waste
2. Storage duration- frequency of desludging and type of the containment unit
3. Infiltration of ground water and exfiltration of wastewater into the ground
4. Climate- temperature
5. Collection methods- human powered emptying or motorized emptying.

5. Notes for trainer

This session does not have a group activity or discussion .However ,this session becomes a base for understanding the selection of appropriate treatment mechanisms for FSS .Hence ,it is encouraged to have discussions on the local conditions and FSS qualities the participants have come across in the past.

6. Bibliography

1. United States Environmental Protection Agency (USEPA). (1994). Guide to Septage Treatment and Disposal. Document EP/625/R-94/002. Washington D.C. 20460.
2. United States Environmental Protection Agency (USEPA) (1999). Decentralized Systems Technology Fact Sheet, Septage Treatment/Disposal. Document EPA 932-F-99-068. Office of Water, Washington D.C.
3. Vinnerås, B., Palmquist, H., Balmér, P., Weglin, J., Jensen, A., Andersson, Å., Jönsson, H. (2006). The characteristics of household wastewater and biodegradable waste - a proposal for new Swedish norms. *Urban Water* 3, p.3-11.
4. WHO (2006), Guidelines for the safe use of wastewater, excreta and greywater, Volume 4, Excreta and greywater use in agriculture, ISBN 9241546859.
5. Troschinetz, A. M., Mihelcic, J. R. (2009). Sustainable recycling of municipal solid waste in developing countries. *Waste Management* 29, p.915-923.
6. PEAL, A.; EVANS, B.; VAN DER WOORDEN, C. (2010): Hygiene and Sanitation Software. An Overview of Approaches. Geneva: Water Supply & Sanitation Collaborative Council (WSSCC).
URL

Session

04

Containment Systems: Sources of Faecal Sludge & Septage

1. Session objectives

- To introduce to the participants objective on the onsite containment system and its types.
- To introduce to the participants, design and working of theseptic tank.
- To make the participants understand how to improve the efficiency of on-site containment unit.

2. Session plan

Duration 45 -minutes

Activity	Time	Material/Method
Containment unit and its objective	5 min	Powerpoint presentation
Types of containment unit	15 min	Powerpoint presentation
Improving efficiency of containment unit	10 min	Powerpoint presentation
Discussion	15 min	Group Discussion, Video

3. Key facts

- Properly designed containment unit is necessary to arrest the solids in black water and digest it appropriately and store the septage.
- There are various types of containment units, and it depends on the local constraints, which is appropriate.
- Design of septic tanks is simple, and key points such as T pipe, baffle wall with opening at appropriate height, roof slab with opening for desludging and vent pipe are crucial.
- Efficiency if the onsite containment unit can be improved by increasing the number of chambers and regulating the flow and providing media for attached growth treatment. Ex. ABR and AF.

4 Learning notes

1. Containment unit and its objectives

The on-site unit which is connected to the user interface and functions to arrest the solids from the blackwater is called as containment unit. Containment unit functions based on physical mechanisms such as filtration, sedimentation and biological mechanism such as anaerobic digestion. The overall aim of having a containment unit is remove the suspended solids to reduce TSS and thereby reduce the BOD and COD of the black water.

A containment unit should also be easily accessible for desludging. FSS from septic tank needs to be emptied at regular intervals in order to maintain its efficiency.

2. Types of containment units

Soak pit / Twin pit

A properly designed and constructed soak pit unit provides filtration by arresting the solids and allowing the water to seep into the adjacent ground. Usually,these pits are built in pairsso that when one is full, the second one is made operational and the content in the first one is allowed to undergo digestion and get converted into humus.

Figure 10: Schematic representation of twin pits / soak pits toilets.

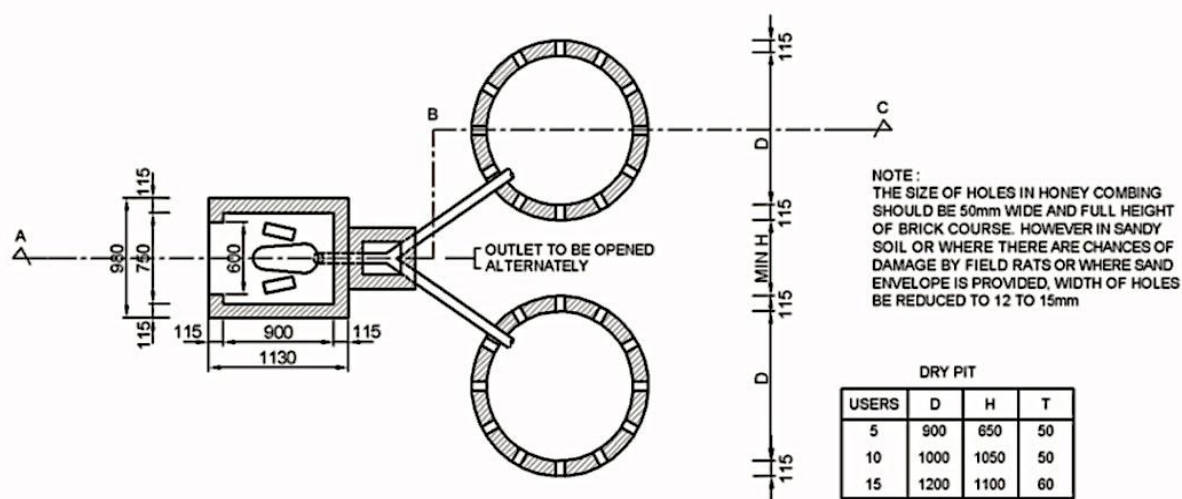

Source :CPHEEO Manual :Sewerage and Sewage Treatment Systems

Soak pits are suitable for rural households since they are easy to construct and have less CAPEX and OPEX. However, soak pits are not advised to be used in places with black cotton soil, rocky strata and/or high ground water table.

A twin pit toilet is the best example of non sewerage sanitation system where the content of the pits can be safely reused in agriculture.

Septic tank

A septic tank is a watertight chamber made of brickwork, concrete, fibreglass, PVC or plastic, through which blackwater from the cistern or pour-flush toilets and greywater through a pipe from inside a building or an outside toilet flows for primary treatment. Settling and anaerobic processes reduce solids and organics, but the treatment is only moderate.

Figure :11 Schematic representation of a septic tank

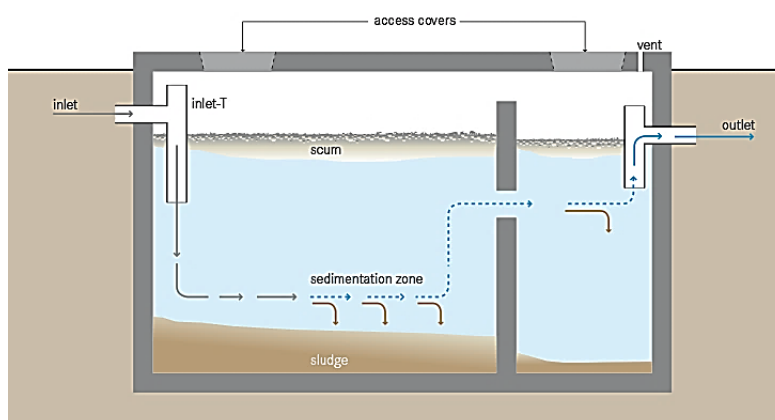

Source: Tilley et al.2014

The hydraulic retention time of at least 24 hours helps to sediment most of the easily settleable solids from the black water. The minimum liquid depth of 1000 mm ensures proper sedimentation. The length to breadth ratio of more than 2 ensures that solids settle in the time taken by water to reach from inlet to the outlet. Some volume of the septic tank needs to be reserved for the

scum that is the oil grease fats. When 2/3 of the tank is full with accumulated sludge and scum, it needs to be desludged. While desludging, it needs to be made sure that a certain amount of sludge should be left behind. This acts as an inoculant for the incoming solids.

Anaerobic baffled reactor

An anaerobic baffled reactor (ABR) is an improved Septic Tank with a series of baffles under which the grey-, black- or the industrial wastewater is forced to flow under and over the baffles from the inlet to the outlet. The increased contact time with the active biomass (sludge) results in improved treatment. ABRs are robust and can treat a wide range of wastewater, but both remaining sludge and effluents still need further treatment in order to be reused or discharged properly.

Figure :12 Schematic representation of ABR

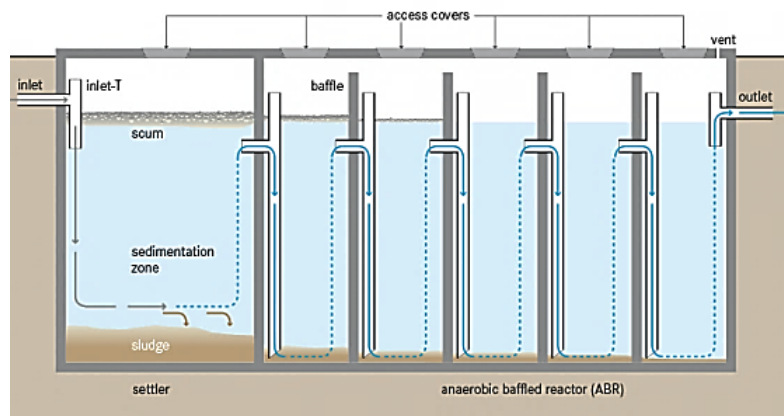

Source: Tilley et al. 2014

Anaerobic up flow filter

An anaerobic filter is a fixed-bed biological reactor with one or more filtration chambers in series. As wastewater flows through the filter, particles are trapped, and organic matter is degraded by the active biomass that is attached to the surface of the filter material. Anaerobic filters are used as a secondary treatment in household black- or greywater systems and improve the solid removal compared to septic tanks or anaerobic baffled reactors.

Figure :13 Schematic representation of anaerobic up-flow filter.

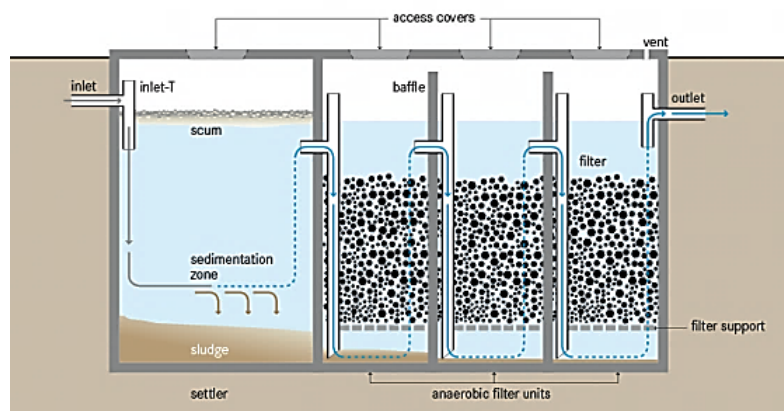

Source: Tilley et. al 2014)

3. Improving efficiency of containment unit

To improve the efficiency of the septic tanks, active sludge is used as inoculant during the starting phase. This results in an immediate digestion of the settled solids. The desludging interval should be fixed. This should be practiced even if the existing septic tanks do not conform to the standard design of septic tanks. While desludging of the septic tank, it should keep in mind that 1/3rd of the septage/sludge should be left behind. Having a greater number of baffles (up to 3) helps in increasing the settling efficiency and treating the liquid effluent to some extent. It is well researched that attached microorganisms have higher efficiency of treatment of wastewater. Hence in some cases, the substrate is provided for the microorganisms to get attached to for further clarifying the water.

5. Notes for trainer

This session does not contain any group work or activities. However, if time permits and depending upon the type of participants, one may choose to show video on how septic tank functions.

LINK- [How a septic tank works?]

You can also show another video on importance of desludging.

LINK- [How septic systems fails and how to restore them?]

6. Bibliography

1. WSSCC/Eawag ;(2005) Household -Centred Environmental Sanitation ,Implementing the Bellagio Principles in Urban Environmental Sanitation ,Provisional Guideline for Decision-Makers, Water Supply and Sanitation Collaborative Council) WSSCC (and Swiss Federal Institute for Environmental Science and Technology) Eawag ,(Duebendorf ,Switzerland .URL
2. CPHEEO ,GoI :(2013) Manual on Sewerage and Sewage Treatment Systems ,Part A :Engineering, 3rd Edition ,Ministry of urban Development ,Government of India .<http://cpheeo.nic.in/Sewerage.aspx>
3. TILLEY ,E ;ULRICH ,L ;LUETHI ,C ;REYMOND ,P ;ZURBRUEGG ,C :(2014) .Compendium of Sanitation Systems and Technologies2 .nd Revised Edition .Duebendorf ,Switzerland :Swiss Federal Institute of Aquatic Science and Technology) Eawag (URL
4. CONRADIN ,K) .Editor ;(KROPAC ,M) .Editor ;(SPUHLER ,D) .Editor :(2010) (SSWM Toolbox. Sustainable Sanitation and Water Management Toolbox .Basel :seecon international gmbh. URL

Session

05

Emptying & Conveyance of Faecal Sludge & Septage

1. Session objectives

- To introduce technology options for emptying and conveyance
- To introduce different types of manually operated mechanical equipment and motorized emptying
- To introduce advanced technologies as mobile dewatering vehicles

2. Session plan

Duration: 45 Minutes

Activity	Time	Material/Method
Technology options for emptying and conveyance	30 min	Powerpoint presentation
Mobile dewatering vehicles	5 min	Powerpoint presentation
Discussion	10 min	Group Discussion
Exercise - Assets for emptying and conveyance of Faecal Sludge and Septage	45 min	Exercise

3. Key facts

- Types of different emptying and conveyance equipment
- Vacuum trucks are the most popular and safest way to empty and convey the FSS
- Vacu-tug is good option for the households having narrow lanes
- Dewatering trucks is a viable option for decreasing the emptying and conveyance cost

4. Learning notes

1. Manually operated mechanical emptying

It provides an overview of three of the most common types of manually operated mechanical pumping equipment that has been developed and trialed; namely, sludge gulper, diaphragm pump and the manual pit emptying technology (MAPET).

Sludge Gulper

The Sludge Gulper was developed in 2007 by the London School of Hygiene and Tropical Medicine (LSHTM). It is a low-cost manually driven positive displacement pump that operates along with the same principles as that of direct-action water pumps. The Gulper has a simple design and can be built using locally available materials and fabrication techniques generally common in low-income countries. It consists of a PVC riser pipe containing two stainless steel ‘non-return’ butterfly valves. One valve, the ‘foot’ valve, is fixed in place at the bottom of the riser pipe and a second valve, the ‘plunger’ valve, is connected to a T-handle and puller rod assembly. As the handle is moved up and down, the two valves open and close in series and sludge is lifted the riser pipe to exit the pump via a downward angled spout. A strainer is fitted to the bottom of the riser pipe to prevent non-biodegradable material from entering and blocking the pump.

Figure 14: Picture of Sludge Gulper



Source: FSM Book, IWA

Table 1: Technical Details of Sludge Gulper

Performance	Purchase/Operating Cost	Challenges
<ul style="list-style-type: none"> • Suitable for pumping low viscosity sludges • Average flow rates of 30 L/ min • Maximum pumping head is dependent on design 	<ul style="list-style-type: none"> • Capital Cost: INR 3000 – INR 90,000 (depending on design) • Operating Cost: Unknown 	<ul style="list-style-type: none"> • Difficulty in accessing toilets with a small superstructure • Clogging at high nonbiodegradable material content • PVC riser pipe prone to cracking • Splashing of sludge between the spout of the pump and the receiving container

Manual Diaphragm Pump

Manually operated diaphragm pumps are simple low-cost pumps capable of extracting low viscosity FS that contains little non-biodegradable materials. They typically consist of a rigid, disc shaped body clamped to a flexible rubber membrane called a diaphragm. An airtight seal between the diaphragm and the disc forms a cavity. To operate the pump, the diaphragm is alternately pushed and pulled causing it to deform into concave and convex shapes in the same way a rubber plunger is used to unblock a toilet. A strainer and non-returning foot valve fitted to the end of the inlet pipe prevents non-biodegradable material from entering the pump and stops backflow of sludge during operation respectively.

Figure 15: Picture of Manual Diaphragm Pump



Source: FSM Book, IWA

Table 2: Technical Details of Manual Diaphragm Pump

Performance	Purchase/ Operating Cost	Challenges
<ul style="list-style-type: none"> • Suitable for pumping low viscosity sludges • Average flow rates of 100 L/ min • Maximum pumping head of 3.5m – 4.5m 	<ul style="list-style-type: none"> • Capital Cost: INR 20,000 – INR 60,000 (depending on manufacturer and model) • Operating Cost: Unknown 	<ul style="list-style-type: none"> • Clogging at high nonbiodegradable content • Difficult to seal fittings at the pump inlet resulting in entrainment of air • Pumps and spare parts currently not locally available

MAPET

In Tanzania, WASTE organization developed and trialed a human-powered vacuum system for the collection and short-distance transport of sludge called the Manual Pit Emptying Technology (MAPET). The MAPET is both the earliest and the most technically advanced manually driven mechanical collection system. It has two separate components, a pump and a 200 liters vacuum tank, each mounted on a dedicated pushcart.

Figure 16: Picture of MAPET



Source: FSM Book, IWA

Table 3: Technical Details of MAPET

Performance	Purchase/Operating Cost	Challenges
<ul style="list-style-type: none"> • Maximum flow rates of between 10 and 40 L/min depending on the viscosity of the sludge and the pumping head • Maximum pumping head of 3 m 	<ul style="list-style-type: none"> • Capital Cost: INR 2,00,000 (1992) (depending on manufacturer and model) • Operating Cost: INR12,000/annum (Maintenance cost) 	<ul style="list-style-type: none"> • Requires strong institutional support for MAPET service providers • A reliance on the importation of a key spare part • MAPET service providers unable to recover maintenance and transport costs from emptying Fees

2. Motorized Emptying

Fully mechanized technologies are powered by electricity, fuel or pneumatic systems. They can be mounted on a frame or trolley for increased mobility, or mounted on vehicles for emptying and transporting large quantities of sludge over longer distances. This section introduces a range of fully mechanized technologies. It includes equipment that is widely available such as motorized pit screw auger, widely used vacuum truck or vacu-tug.

Jalodbust

Jalodbust is a motorized emptying device which works on the piston pump principle. It is manufactured by JALODBUST. The equipment is portable, battery operated and is a sanitary sludge handling machine with agitator. The working principle of the agitator is based on the shock wave principle where the displacement is done by the movement of the piston. There is a gland to keep it water tight and a lever is used to create shock waves for agitator. It can produce up to 400 psi water jet to clean sewer blockages and it liquifies sludge by removing limiting viscosity. Some product specification are as follows:

- Can desludge 500-800 litres per hour
- 2500 litres can be desludged per battery charge
- 50 m horizontal distance and 10 m vertical lift
- The machine weighs 30kgs
- 24-volt 40 AH Battery
- 200-500-watt motor

Pit Screw Auger

Motorized pit screw augers (SAS) are based on the Archimedean screw design. Motorized SAS are currently under development with prototypes which consist of an auger placed inside a plastic riser pipe and protruding by approximately 5 to 15 cm from the bottom end of the pipe. An electric motor is mounted on top of the riser pipe where it connects to the auger. To operate, the riser pipe is placed in the FS and as the auger turns, FS is picked up by cutting blades at the bottom of the auger and lifted up the riser pipe along the auger flights. A downward angled spout at the top of the riser pipe allows material to be discharged into a collection container. Weighing between 20 and 40 kg, motorized SASs can be operated by one person.

Figure 17: Picture of Pit Screw Auger



Source: FSM Book, IWA

Table 4: Technical Details of Screw Auger

Performance	Purchase/Operating Cost	Challenges
<ul style="list-style-type: none"> • Can handle liquid sludge and a small amount of non-biodegradable waste • flow rates of over 50 L/min. pumping head of at least 3m (difficulty emptying from variable depths) 	<ul style="list-style-type: none"> • Capital Cost: INR 45,000 – INR 50,000 • Operating Cost: Unknown 	<ul style="list-style-type: none"> • The fixed length of the auger and riser pipe • Unsuitable for use with dry sludge and large quantities of non-biodegradable waste • Difficult to clean after use • Difficult to manoeuvre due to weight and size

Vacuum Trucks

Pumping systems that utilize a vacuum have been shown to be effective at removing FS from onsite water-retaining systems. Vacuum pumps may be mounted on heavy duty trucks or trailers, on lighter duty carts or even on human powered carts when smaller volumes are being collected, or for use in dense urban settings not accessible by larger trucks. Vacuum pumps often utilize the truck's transmission to power the system, although independently powered, dedicated motors can also be used. Vacuum trucks are available in a wide variety of sizes and models to accommodate different needs, with the most commonly used in India having capacities ranging from 3000 liters to 12,000 liters.

Vacuum pumps are sized based on lift elevation, pumping distance, the volume of sludge to be removed, and the volume of the tank. When designing collection and transport systems, local manufacturers should be consulted in order to determine what equipment is available. Product specifications must be checked to verify that the proposed truck is adequate for the need. Various factors influence the selection of a vacuum truck by a service provider, including:

- typical volume of the tanks or vaults that will be serviced;
- road widths and weight constraints;
- distance to the treatment plant;
- availability;
- budget; and
- skill level of the operators.

Figure 18: Components of Vacuum Trucks

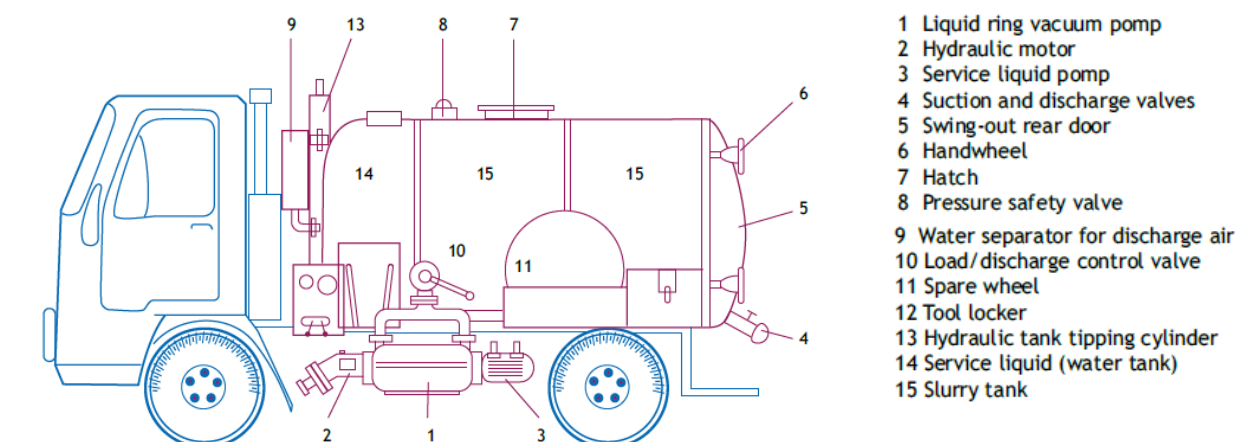



Source: FSM Book, IWA

Vacutug

Vacutug is a smaller version of the trailer mounted type of vacuum truck. The need of such a smaller size desludging equipment arises from the fact that not all the containment units are easy to access. Especially in the unorganized settlements such as urban slums, the access roads are small and a vacuum truck cannot be driven to the household. Hence, vacutug is used to empty the contents of the septic tank in batches and empty it into the bigger truck. The tugs can be as small as 300 L. The most important thing which makes a vacutug is to keep in mind that it should be easy enough to pull it by persons or vehicles.

Vacutug - I			
		<ul style="list-style-type: none"> • Self-driving 4-wheeler • Engine powers both the pump and drive train • Tight turning radius, easy to manoeuvre • Vertically mounted sludge collection tank • Suitable for use on narrow streets 	
Tank capacity	Pump	Engine	Max speed
700 L	MEC 2000/P	10.5 hp diesel	5 kmph

Vacutug - II			
		<ul style="list-style-type: none"> • 2-wheeler trailer unit • Towed by tractor or large pickup truck • Horizontally mounted sludge collection tank • Suitable for use on wide streets and highways 	
Tank capacity	Pump	Engine	Max speed
2000 L	MEC 2000/P	12 hp diesel	45 kmph

Vacutug - III			
		<ul style="list-style-type: none"> • 3-wheeler unit • Engine powers both the pump and drive train • Tight turning radius, easy to manoeuvre • Vertically mounted sludge collection tank • Suitable for use on narrow streets and highways 	
Tank capacity	Pump	Engine	Max speed
700 / 2000 L	MEC 2000/P	12 hp diesel	30 kmph

Vacutug - IV



- 4-wheeler trailer unit
- Horizontally mounted sludge collection tank
- Top cover conceals engine & pump
- Cargo deck sides fold down
- Suitable for narrow streets and long distances

Tank capacity	Pump	Engine	Max speed
1000 L	MEC 2000/P	12 hp diesel	70 kmph

Transfer Station

The location of formal/regulated disposal sites are often far out of town and therefore operators are required to travel long distances to dispose of the septage. These long distances result in high fuel costs for the trucks (which is the largest operating expense for them), and hence it also means higher emptying fees for the households due to truck operators charging higher rates for the longer distances they have to travel.

In a study, it has also found that distances from the emptied septic tank to a regulated disposal facility of greater than 5 – 10 kms often result in illegal dumping of FSS in low lying areas or nalla's or in rivers. In order for operators to get enough trips done in a day, while keeping the service affordable, has resulted in this illegal practice, which has obvious health and environmental issues. One of the option / solutions to these issues is installation of transfer station. There can be different approaches for setting up of transfer stations

Figure 19: Transfer Station

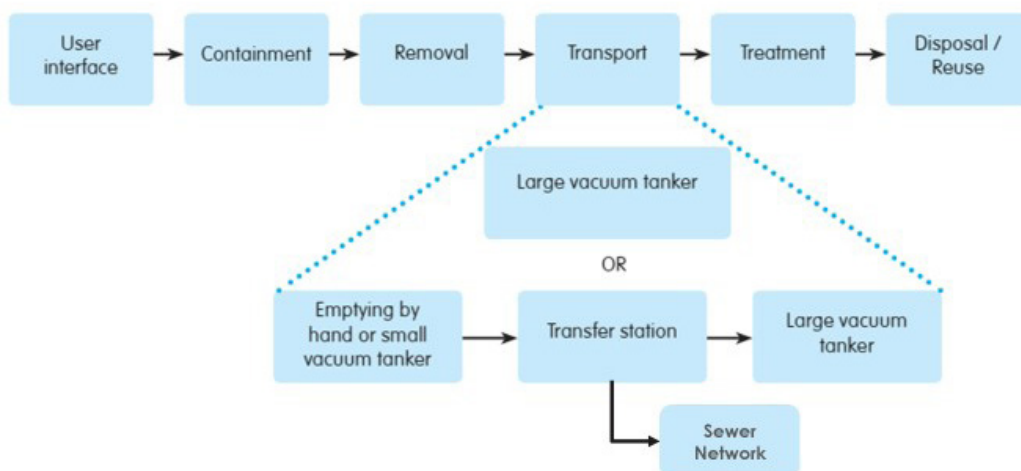

Network-connected station

The sewer discharge station (SDS) is much the same as the simple transfer station, but is directly connected to a conventional gravity sewer main so that the septage can be transported to a semi-centralized secondary treatment system, as shown in figure 9. This avoids the need for the septage to be carted away by a larger vacuum tanker.

A variation on this option, is to use existing sewer lifting stations as septage transfer stations, where the septage is discharged directly into the wet well of the pumping station. These options are only viable where septage (sludge with a high liquid content) is retrieved from septic tanks and disposed in the transfer station. Utilities and asset owners discourage the disposal of concentrated sludge directly into the sewers as it can lead to blockages, especially if the sludge is too dry (Strande et al. 2014). Septage emptied into the SDS is released into the sewer main either directly by gravity or at timed intervals (e.g., by pumping) to optimize the performance of the sewer and of the wastewater treatment plant, and/or reduce peak loads (Tilley et al. 2008). The slope of the floor should ensure that the sludge gravitates towards the outlet pipe and is discharged to the sewer.

Figure 20: Network Connected Transfer Station

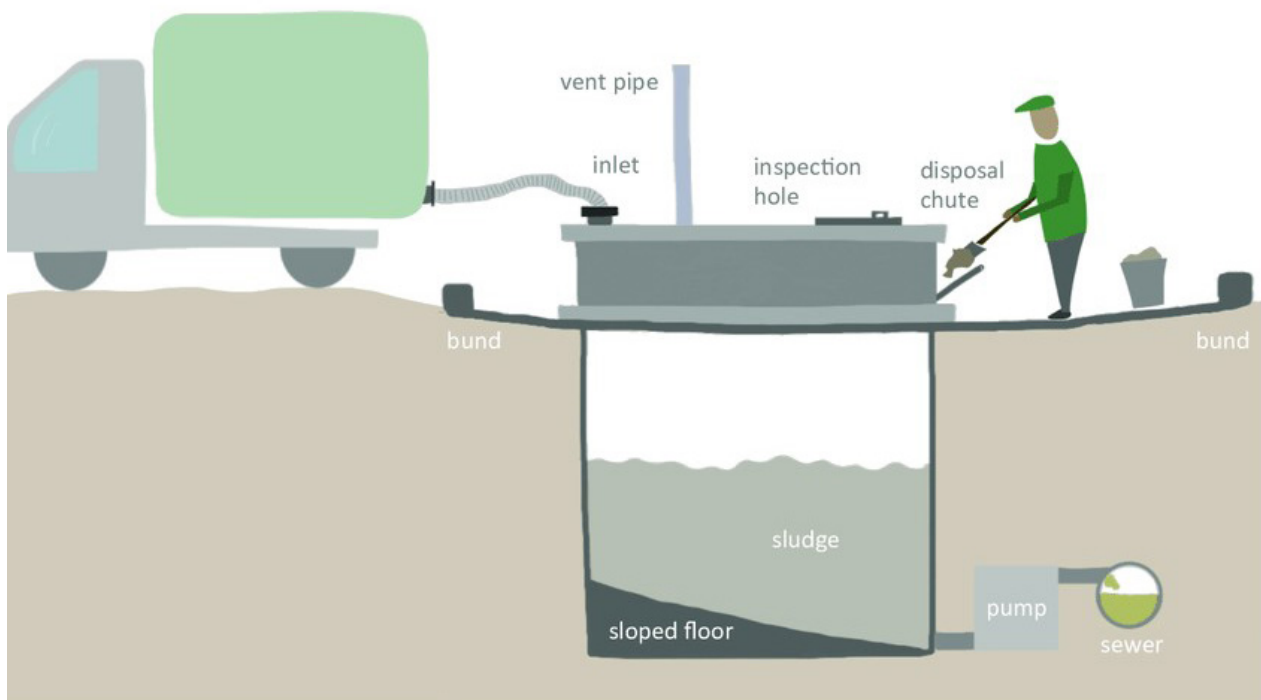

Modular Transfer Station

It allows easy access for the disposal of the sludge into the portable container by smaller vacuum tankers or manual operators, a raised platform may need to be constructed. Figure 7 shows how a detachable tanker, for example, can be parked under a raised platform. Septage is discharged

into the top of the tanker. When the tanker is full, it is replaced with an empty one, and the full one is transported for emptying at a legal dumping site.

Figure 21: Modular Transfer Station

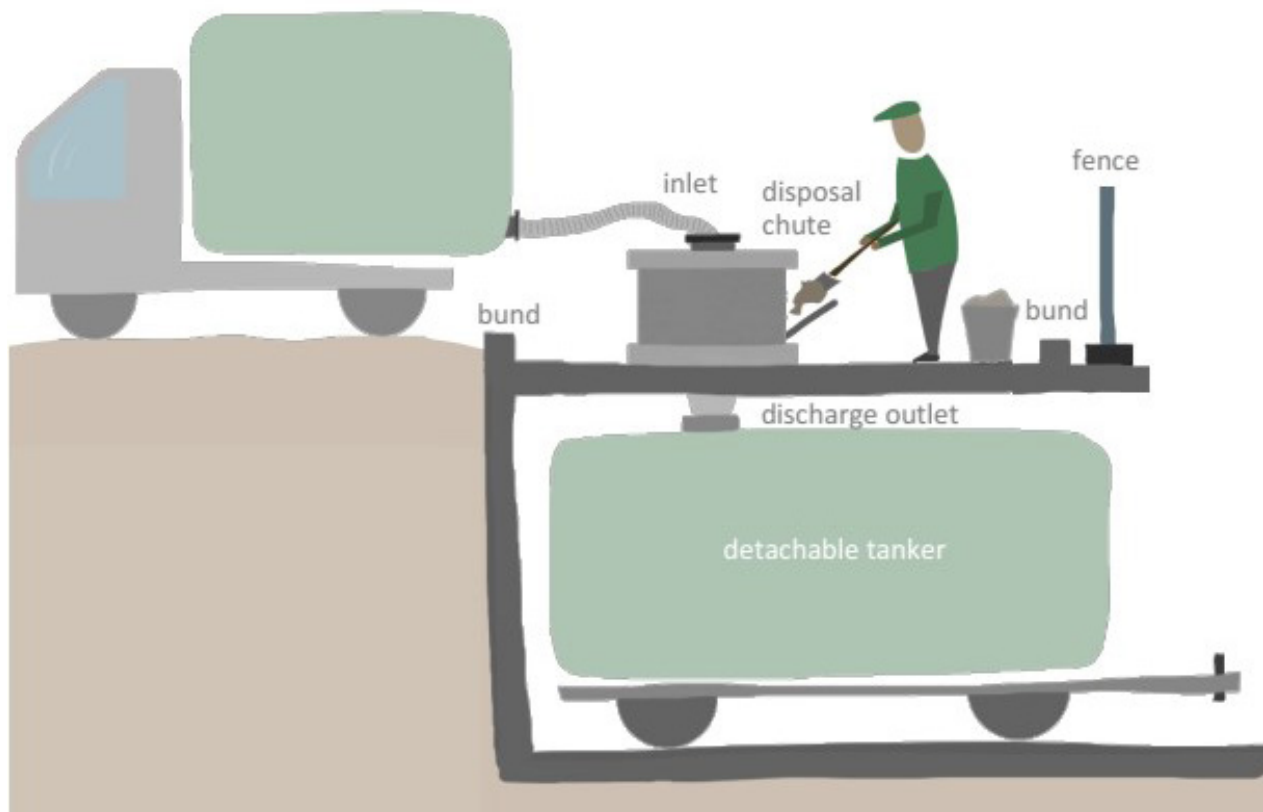

Mobile Transfer Stations

It consists of easily transportable containers providing temporary storage capacity at any point near the structure being emptied - essentially a tank fitted on a wheeled chassis. Examples of such transfer stations include motorised collection vehicles, or tanker trailers pulled via a truck or tractor.

The stations are sited in any area where multiple trips by small-scale transport equipment are required. The main advantage of these stations is that they sidestep the complex and often lengthy procedures required for siting fixed stations in high-density settlements. They can also double as secondary transport containers once full as they can be easily driven or towed to the final disposal site.

If towed, the motorised vehicle towing the container is capable of performing other related or unrelated duties thus allowing for cost savings and potential for increased revenue. Such systems have reportedly been used in places such as Maseru, Lesotho (Strauss and Montangero, 2002).

Figure 22: Mobile Transfer Station

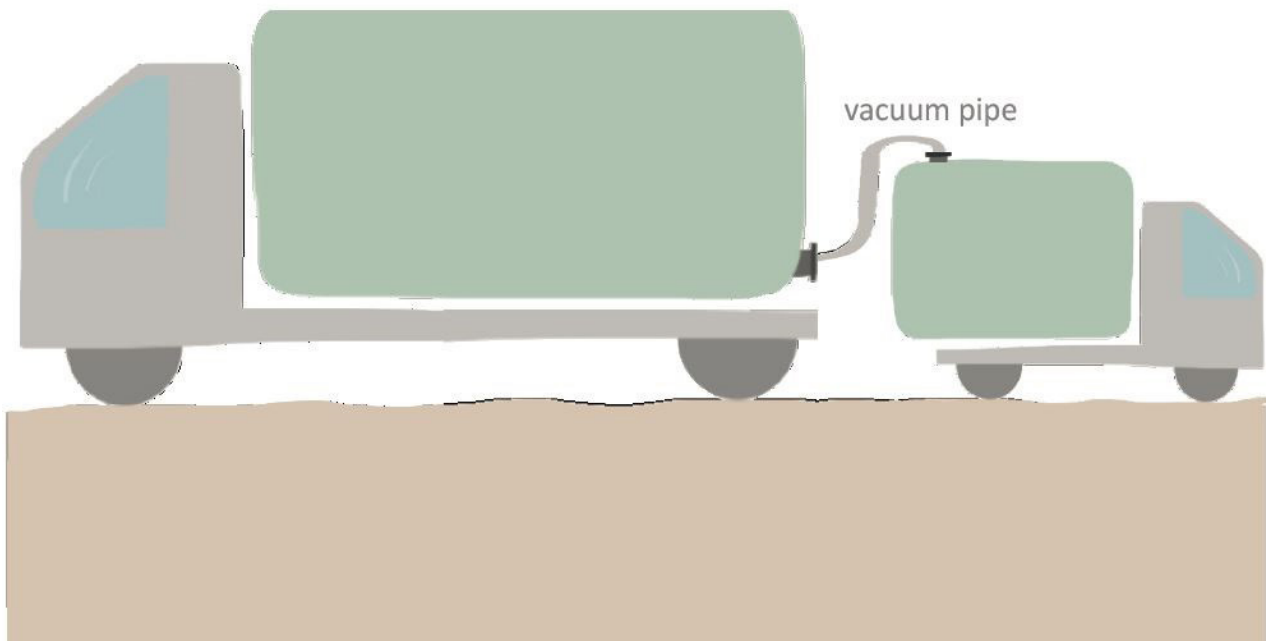

Mobile Dewatering Truck

Dewatering truck is a vacuum truck which desludges the septic tank and simultaneously separates the solids from the septage. Usually, there is more than 95% water in the faecal sludge. The filtered water can be put back into the septic tank as its characteristics are much better than the septic tank effluent. It dewatered around 75 – 80% of liquid from the sludge as per the capacity of the system. The separated solids now have significantly less volume and weight less. Thus, it not allows servicing more households but also improves the fuel efficiency of the truck.

Figure 23: Mobile Transfer Station



Source: ABCO, www.pumper.com

5. Notes for trainer

This session does not contain any group work or activities. However, if time permits and depending upon the type of participants, one may choose to show video on how septic tank is desludged using mobile dewatering vehicle and dewatered sludge.

Link - [ABCO Mobile Dewatering Vehicle](#)

6. Bibliography

1. STRANDE, L.; RONTELTAP, M.; BRDJANOVIC, D. (2014): Faecal Sludge Management - Systems Approach for Implementation and Operation. London: IWA Publishing URL
2. EAWAG/SANDEC (2008): (Sandec Training Tool 1.0, Module 5). Duebendorf: Swiss Federal Institute of Aquatic Science (EAWAG), Department of Water and Sanitation in Developing Countries (SANDEC) URL
3. Strauss, M., Montangero, A. (2002). Faecal Sludge Management – Review of Practices, Problems and Initiatives. Dubendorf: EAWAG / SANDEC.
4. USEPA: Handbook on Septage Treatment and Disposal
5. Chowdhry, S., Koné, D. (2012). Business Analysis of Faecal Sludge Management: Emptying and Transportation Services in Africa and Asia. Seattle: The Bill & Melinda Gates Foundation.
6. ERE Consulting Group and Indah Water Konsortium (2012). Landscape Analysis and Business Model Assessment in Faecal Sludge Management: Extraction and Transportation Model in Malaysia. Seattle

Session

06

Treatment Mechanism for Faecal Sludge & Septage

1. Session objectives

- To understand the treatment targets and specific treatment objectives for FSS.
- To understand the different types of treatment mechanisms and selection of treatment mechanisms.
- To discuss different treatment concerns pertaining to the treatment mechanisms which needs to be considered for treatment of FSS.

2. Session plan

Duration 45 -min

Activity	Time	Material/Method
Treatment targets	10 min	Powerpoint presentation
Physical mechanisms	10 min	Powerpoint presentation
Biological mechanisms	10 min	Powerpoint presentation
Chemical mechanisms	10 min	Powerpoint presentation
Treatment concerns	5 min	Powerpoint presentation

3. Key facts

- Treatment target needs to be set depending upon local context and demands to make FSSM economically viable.
- Treatment mechanisms are the same as that of wastewater treatment; however, their design needs to be tweaked to achieve the treatment targets.
- Source of FSS needs to be checked as heavy metals cannot be removed during treatment and this can hamper the reuse and disposal of FSS.
- Monitoring of end products is necessary as it keeps a check on the treatment mechanisms.

4. Learning notes

1. Treatment targets

The ultimate aim of any treatment process or a facility is to ensure protection of human and environmental health and not just to achieve the discharge standards .However ,the treatment targets should be appropriate and should be relevant to the local context .Specific treatment objectives when it comes to treatment of FSS are to reduce the water content of the sludge, stabilize and disinfect the liquid and solids.

2. Physical mechanisms

Physical mechanisms are based on the physical properties of the constituents .Screening ,filtration, sedimentation ,heat drying etc are the type of physical mechanisms.

Screening helps to remove the solid waste from the FSS which can hinder the subsequent processes .Gravity separation is based on the specific gravity of the constituents and helps to remove the solids and fat-oil-grease from the FSS .Filtration processes helps to separate the liquid from the solids using drying bed .Heat drying helps to drive away the moisture.

3. Biological mechanisms

Biological mechanisms are based on the organic content and their digestibility .Biological processes such as anaerobic and aerobic digestion or composting helps to transform organic waste into nutrients.

Anaerobic digestion generates methane gas which can be used as fuel to generate heat or electricity. Co-composting of dewatered sludge transforms the organic content of the sludge into compost which is rich in nutrients.

4. Chemical mechanisms

Chemical mechanisms are mainly used for assisting the other mechanisms. Coagulation and flocculation assist the solid-liquid separation and accelerate the process. Alkaline stabilisation uses chemicals to stabilise and disinfect the FSS.

5. Treatment concerns

Source of FSS needs to be monitored in order to choose the appropriate and maintain the treatment processes after the construction of the treatment facility. Heavy metals cannot be removed using the treatment mechanisms discussed above and hence sludge from the industries should be handled separately. The filtrate from the physical mechanisms such as gravity settling and filtration can be alkaline, which can hamper the treatment of the liquid fraction of the FSS. Monitoring of the end products from the treatment facility is highly recommended so that it keeps a check on the efficiency and operational conditions for preceding treatment mechanisms.

5. Notes for trainer

This session does not have any group activity or discussions involved; however, it is important that the participants are clear with the treatment mechanisms, this session forms the basis of subsequent sessions of formation of treatment chain for FSS treatment.

6. Bibliography

1. EAWAG/SANDEC (2008): (Sandec Training Tool 1.0, Module 5). Dübendorf: Swiss Federal Institute of Aquatic Science (EAWAG), Department of Water and Sanitation in Developing Countries (SANDEC). URL
2. USEPA: Handbook on Septage Treatment and Disposal
3. Heinss, U., Larmie, S.A. (1998). Solid separation and pond systems for the systems for the treatment of faecal sludges in the tropics. EAWAG. Dübendorf, Switzerland, EAWAG.
4. Metcalf and Eddy (2003). Wastewater Engineering: treatment, disposal, reuse. Tchobanoglous, G., Burton, F.L. eds. McGraw-Hill Book Company.
5. Vesilind, P.A. (2001). Introduction to stabilization. Sludge into Biosolids – Processing, Disposal and Utilization. Edited by L. Spinosa and P. A. Vesilind. IWA Publishing, United Kingdom.
6. Kopp, J., Dichtl, N. (2001). Characterization. Sludge into Biosolids – Processing, Disposal, Utilization. Edited by L. Spinosa and P. A. Vesilind. IWA Publishing, United Kingdom.

Session

07

Selection of Faecal Sludge & Septage Treatment Mechanisms

1. Session objectives

- To understand and discuss the specific treatment objectives with relevance of the characterisation ratios.
- To discuss and shed some light on the selection of treatment mechanisms to achieve the treatment objectives.

2. Session Plan

Duration 45 -minutes

Activity	Time	Material/Method
Treatment objectives	10 min	Powerpoint presentation
Selection of treatment mechanisms	20 min	Powerpoint presentation
Discussion	15 min	Group Discussion

3. Key facts

- Defining treatment objectives to obtain the right end products for reuse or disposal.
- Dewatering is important objective and helps to optimise the treatment system thereby reducing the cost of treatment.
- Local context is an important criterion and can be deciding factors for selection of treatment mechanisms

4. Learning notes

1. Treatment objectives

Dewatering

One of the very important treatment objectives of faecal sludge and septage is dewatering. Dewatering helps to reduce the volume of sludge to be handled and treated using other treatment mechanisms, hence it reduces the CAPEX significantly. Separating the solids and liquid stream simplifies the treatment of faecal sludge and septage and helps to optimise the process. Ex. In case of heat drying, dewatering will save a significant amount of energy.

Pathogen removal

The second most important objective is pathogen removal. Pathogen removal is important from the discharge and reuse point of view of the end products. Faecal sludge and septage is known to contain high number of pathogens and hence indiscriminate disposal of it may result in cross contamination of the water resources. Reduction of pathogen is achieved by various ways such as – starvation, predation, exclusions, desiccation, temperature.

Nutrient recovery

Nutrient recovery is a specific treatment objective which is very important when we are intending to use the end products as soil supplements for improving its characteristics. Faecal sludge and septage contain good amount of nutrients. If managed properly, these nutrients can be used as a supplement to synthetic fertilisers in agriculture. However, if not managed properly, it leads to eutrophication of water bodies and further it may lead to contamination of drinking water resources.

Stabilisation

Stabilisation of faecal sludge is also one treatment objective. Faecal sludge contains more organic solids which needs stabilisation before it can be discharged into the environment. Stabilisation reduced the oxygen demand of the liquid fraction of the faecal sludge. The need of stabilisation can be assessed using parameters such as volatile solids, BOD and COD.

2. Treatment Approaches in FSSM

There can be different treatment approaches in FSSM which is dependent on the quantification and characterization of FSS. In the first step, if the quantity of FSS is less than 10 KLD then the Deep Row Entrenchment can be the simple, low cost and less O&M approach in FSSM though the limiting factors has to be considered while site selection. It is recommended that the selected site should be away from water bodies and high groundwater table areas.

Figure 24: Treatment Approaches In FSSM

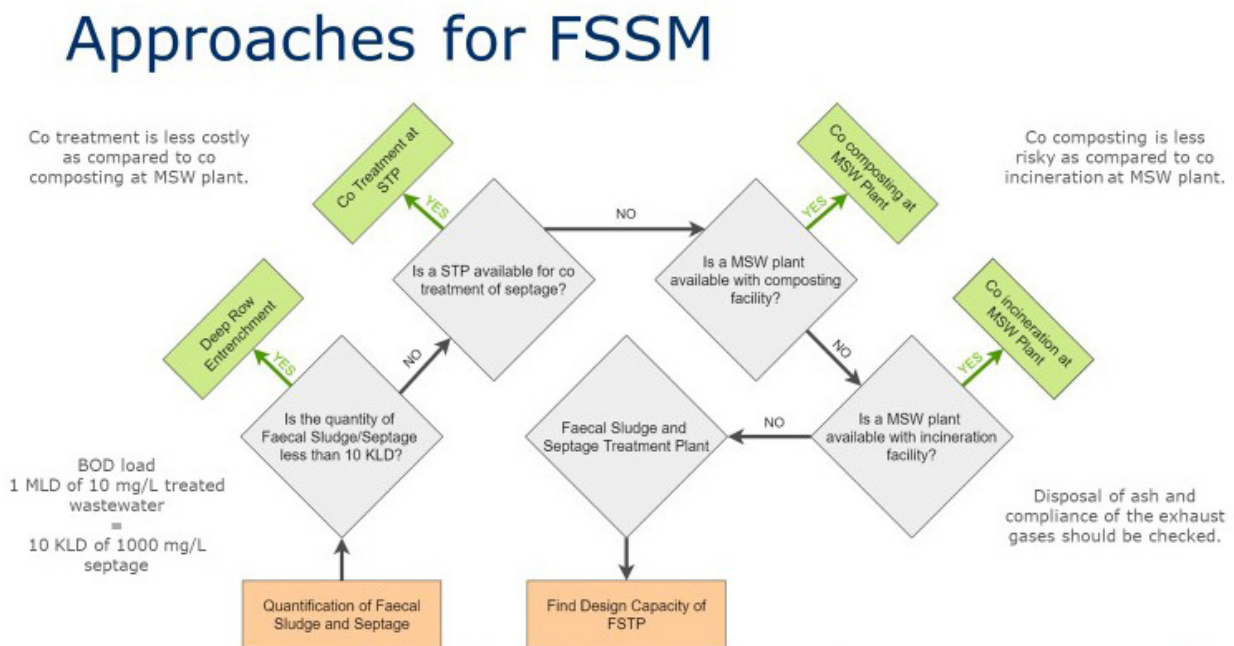

In the next approach, if the FSS is above 10 KLD and there is availability of STP in the locality/ULB level then it can be co-treated with Sewage Treatment plant. Usually, co-treatment in STP approach is less costly than the co-composting or separate FSTP. The study has to be carried out for the proper application of FSS at appropriate point at STP (i.e. at manhole chamber before inlet or at screen or at sludge management facility)

If there is no STP with ULB but there is availability of municipal solid waste processing facility with organic waste composting then ULB can select the approach of co-composting of FSS with municipal waste processing facility. In this case, FSS has to be dewatered and solid content has to be in the range of 40-45% while co-composting it with organic waste composting. In other case, if composting facility is not available but incineration facility is there at municipal waste processing facility then dried FSS can be co-incinerated. But in this case, FSS has to be dewatered and dried and solid content has to be around 80% or more. This is not a feasible option compared to co-composting approach as it demands high energy, maximum human resources, proper compliance for disposal of ash and exhaust gases.

In the last when all above options are not applicable then there is need of specific faecal sludge and septage treatment plant (FSTPs). There are different technologies as mechanized or non-mechanized or hybrid for the FSTPs.

3. Selection of treatment mechanisms

The selection of the treatment mechanisms is governed by certain criteria which are listed in the figure below. However, it needs to be understood that these criteria are not inclusive and there can be other criteria as well.

Table 5: Selection criteria for treatment mechanisms

Treatment performance	Local context	O&M requirements	Costs
<ul style="list-style-type: none"> Effluent and solids quality according to the discharge / reuse standards 	<ul style="list-style-type: none"> Characteristics of sludge (dewaterability, solids concentration, stabilisation, spread ability) Quality of the frequency of the sludge to be received at treatment facility Climate Land availability and its cost Interest in the enduse 	<ul style="list-style-type: none"> Availability of skilled persons for operation-maintenance and monitoring Availability of spares locally in case of mechanical equipment. 	<ul style="list-style-type: none"> Investment costs covered (land acquisition, infrastructure, human resources, capacity building and training) O&M costs Affordability for households and ULB

Treatment performance

The primary criteria are that the treatment facility should be able to produce end products meeting the standards of discharge/ enduse.

Local context

Most important criteria are the local context. The characteristics of the sludge and its characterisation ratios determine the degree of stabilisation and dewaterability etc. The frequency of desludging affects the quality of the sludge. Hence, if the frequency of the desludging is high, there is a possibility of having faecal sludge. In that case, stabilisation of sludge becomes important.

Climate plays an important role in case of all-natural treatment mechanisms such as evaporation, evapotranspiration and stabilisation.

Land availability and its cost of acquisition must also be considered before finalising the treatment mechanisms. In cases where the land is not available and acquisition of it is costly or time consuming, it is advisable to go for treatment mechanisms demanding less area.

If there is interest in the use of end products of treatment then treatment mechanisms suitable to produce those end products in demand should be chosen. Ex. In cases where there is a demand for biochar, pyrolysis will be suitable treatment mechanisms for pathogen reduction.

O&M requirement

Availability of resources such as skilled persons ,spares etc at local level is very important .In absence of local availability of the resources ,no treatment technology is going to be economically viable in spite of it producing very high-quality end product.

Costs

The CAPEX and OPEX of the technology are also one of the criteria which is thought as the only criteria. Affordability of the complete project to the ULB or the end beneficiaries such as households should also be checked.

5. Notes for trainer

This session does not contain any session; however, it is recommended to have a discussion with the participants on the selection criteria for treatment mechanisms. The participants can be asked to identify other criteria for selection of treatment mechanisms.

6. Bibliography

1. STRANDE, L.; RONTELTAP, M.; BRDJANOVIC, D. (2014): Faecal Sludge Management - Systems Approach for Implementation and Operation. London: IWA Publishing URL
2. EAWAG/SANDEC (2008): (Sandec Training Tool 1.0, Module 5). Duebendorf: Swiss Federal Institute of Aquatic Science (EAWAG), Department of Water and Sanitation in Developing Countries (SANDEC) URL
3. Technical Note on Shallow and Deep Trenches for Faecal Sludge or Septage by Water, Sanitation and Hygiene Institute, 2019

Session

08

Formation of Faecal Sludge & Septage Treatment Technologies

1. Session objectives

- To understand the treatment chain for faecal sludge and septage treatment.
- To introduce the participants to natural FSS treatment units.
- To understand the methodology for selection of appropriate treatment component based on elimination-based approach.
- To discuss case studies of faecal sludge and septage treatment plants in India.

2. Session Plan

Duration 60 -minutes

Activity	Time	Material/Method
Stages and mechanisms for FSS treatment	10 min	Powerpoint presentation
Natural FSS Treatment units	20 min	Powerpoint presentation
Elimination based approach for making treatment chain	15 min	Group discussions
Case studies and Discussion	15 min	Powerpoint presentation and Discussion

3. Key facts

- FSS treatment facility consist of up to four stages, each having specific treatment objective.
- FSS treatment facility consists of multiple components to achieve the desired treatment objectives.
- Defining the right treatment objective is the key to selection of appropriate treatment components for FSS treatment facility

4. Learning notes

1. Stages of FSS treatment

There are multiple stages of FSS treatment and each stage has a specific treatment objective. The figure below shows all the stages and treatment mechanisms under each stage and examples of treatment units for that stage.

Figure 25: Stages of treatment in FSS

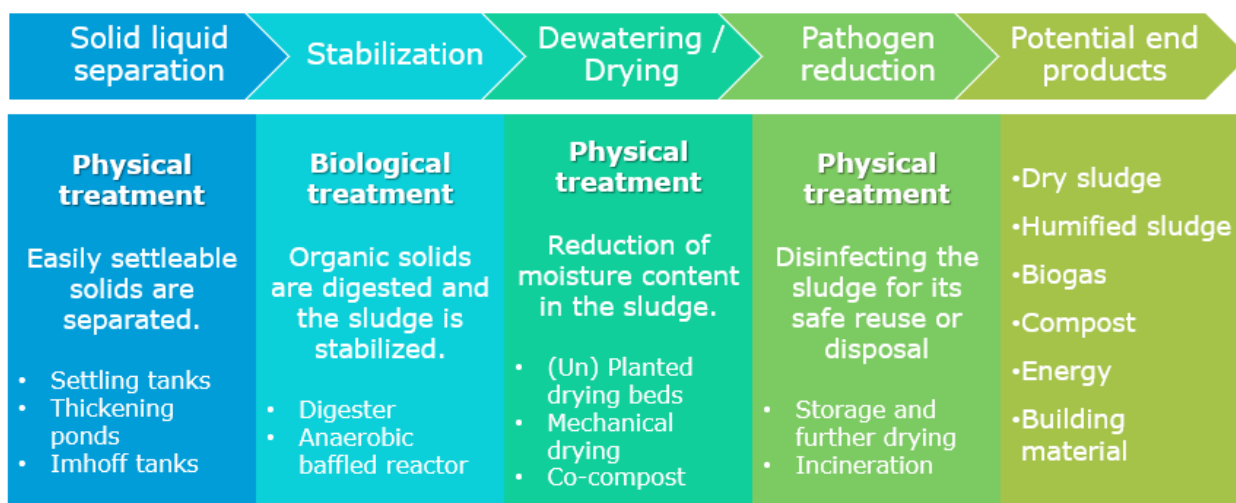

2. Natural FSS treatment units

Settling Thickening Tank

Settling thickening tanks are sedimentation tanks which are designed based on the settling velocities of the suspended particles in the FSS. The difference in the specific gravity aids the settling process. The FOG has lower specific gravity as compared to the water and hence, floats on the top of the tank. The solids which settle down in the tank are further compressed and thickened by the hydrostatic pressure from the water above. The HRT of the settling thickening tank is in hours, however, SRT can range from 10-30 days. The properly designed and well-operated settling thickening tank thickens the FSS of solid content as low as 0.5% up to 12%.

Anaerobic digester

Anaerobic digester is used for stabilization of solids in the faecal sludge. As discussed in previous sessions, faecal sludge has a higher content of slowly biodegradable COD. Hence, to stabilize these solids, a mesophilic anaerobic digester with SRT of 20 – 30 days is required. Anaerobic digestion of organic solids results in methane gas which can be used as fuel to generate heat and electricity. Anaerobic digestion also reduces the volume of sludge and increases the dewaterability of the sludge. Anaerobic digestion is a very sensitive process and a lot of control parameters need to be monitored if the aim is to extract maximum methane from the FSS. Hence, O&M of an anaerobic digester is high as skilled manpower with good understanding of digesters is needed.

Unplanted / Planted drying beds

Unplanted and planted drying beds are gravel beds made out of civil aggregates of different sizes. The aim of the drying beds, as the name suggests, is to dewater and dry the sludge. In the case of a planted drying bed, mineralization of the sludge also takes place. This is mainly due to the operating cycling of the planted drying bed. Usually multiple (around 8-12) unplanted drying beds are built together and fed at different intervals. During each load, it has to be taken care that not more than 300 mm of sludge is to be loaded. Increasing the loading beyond 300 mm significantly increases the drying period and might also result in inadequate drying. The unplanted drying beds are operated on the cycle period of weeks depending on the climatic conditions. After one cycle, the bed is dried, bio solids are taken out of the bed. Planted drying beds, on the other hand, are operated for years and loading is done intermittently.

Sludge storage yard

A sludge storage yard is a covered space, where the dried solids from the drying beds can be stored for a couple of days before sending them out for disposal or reuse. The space should be well ventilated and should have partitions so that the batch of solids can be segregated.

3. Elimination based approach

The flow chart given below systematically describes the selection method for treatment units for FSS. It is a decision tree with criteria such as quality and quantity of sludge, its dewaterability, spread ability and use of end products which decides the suitable treatment unit for FSS.

FIGURE 26 : DECISION MAKING FLOW CHART FOR SELECTION OF SUITABLE FSS TREATMENT UNIT.

Selecting a context-appropriate combination of faecal sludge treatment technologies

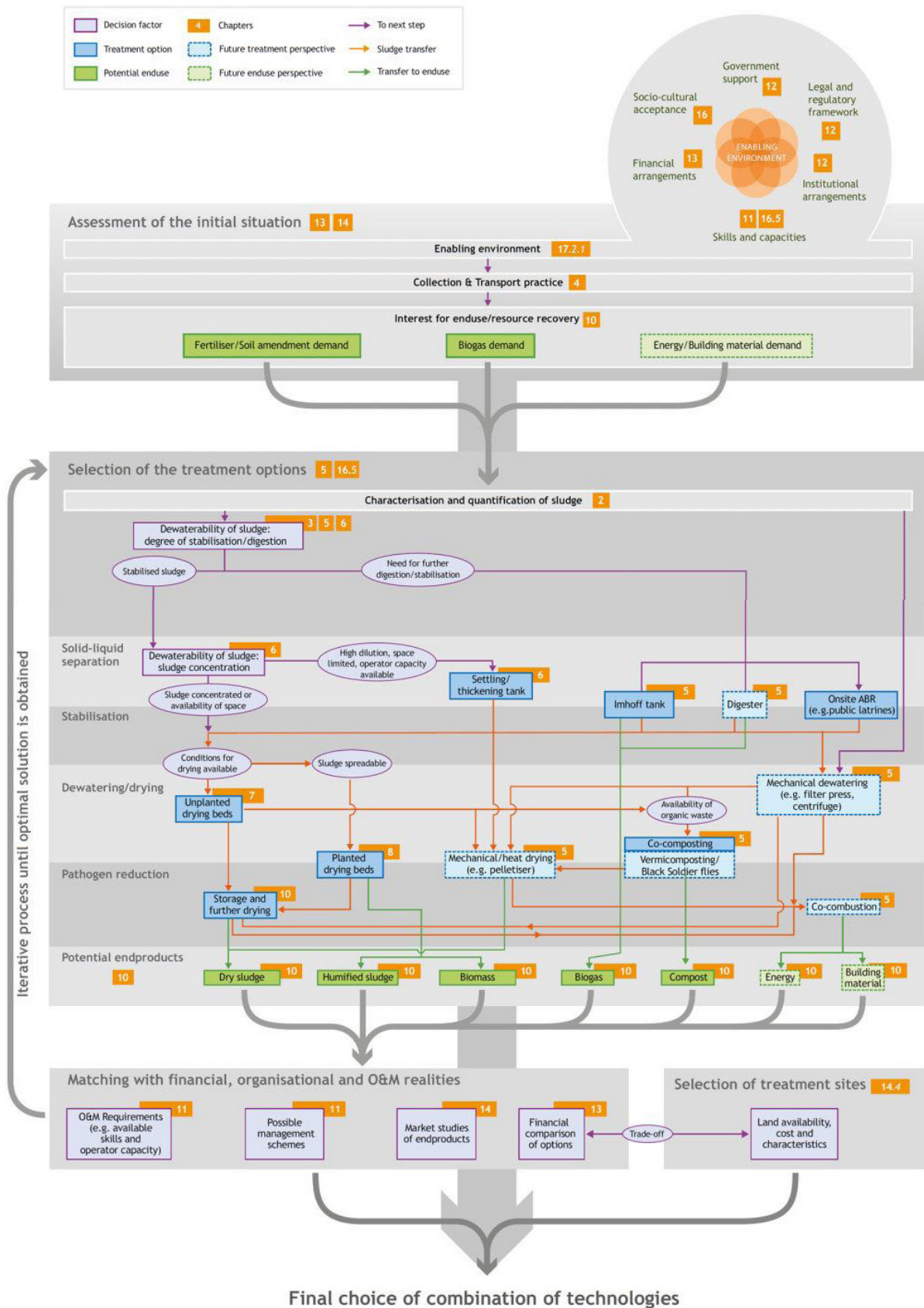

Source: faecal sludge management: system approach for implementation and operation

4. Case studies

In this section four case studies pertaining to FSTP and co treatment of FSS at STP has been discussed. Following are the FSTPs which have been discussed in the session;

1. SeTP, Bhubaneshwar, Odisha (operational)
2. SeTP, Rudrapur, Uttarakhand (under tendering)
3. FSTP, Port Blair, Andaman and Nicobar Island (under tendering)
4. Co treatment facility at STP, Puri, Odisha (Operational)

More examples of FSTPs can be found in the Compendium of FSTPs in India published under SCBP by NIUA.

5. Notes for trainer

This session contains a group discussion based on the topic “Elimination based approach for selection of suitable treatment unit for FSS”. For this each participant should be asked to go to Part A of the module wherein they can refer to the diagram given under this session. A systematic step by step discussion, starting from the defining treatment objectives based on the end products should be started. The characteristics of the sludge should be decided, and appropriate treatment units should be selected.

If time permits and depending upon the type of participants, you may also choose to convert this into an activity, wherein the participants will derive maximum possible treatment chains for treatment of FSS using the decision-making tree diagram.

6. Bibliography

1. STRANDE, L.; RONTELTAP, M.; BRDJANOVIC, D. (2014): Faecal Sludge Management - Systems Approach for Implementation and Operation. London: IWA Publishing URL
2. EAWAG/SANDEC (2008): (Sandec Training Tool 1.0, Module 5). Duebendorf: Swiss Federal Institute of Aquatic Science (EAWAG), Department of Water and Sanitation in Developing Countries (SANDEC) URL
3. USEPA: Handbook on Septage Treatment and Disposal
4. Cofie, O., Koné, D. (2009). Co-composting of faecal sludge and organic solid waste Kumasi, Ghana – Case study of sustainable sanitation projects. Sustainable Sanitation Alliance (SuSanA).
5. Klingel, F., Montangero, A., Koné, D., Strauss, M. (2002). Fecal Sludge Management in Developing Countries. A planning manual. EAWAG: Swiss Federal Institute for Environmental Science and Technology Sandec: Department for Water and Sanitation in Developing Countries.

Session

09

Designing of Solid Liquid Separation Unit: Settling Thickening Tank

1. Session objectives

To understand the design procedure for settling thickening tank and to design the treatment unit for a case given in the workbook.

2. Session plan

Duration- 45 minutes

Activity	Time	Material/Method
Design of settling thickening tank	45 min	Powerpoint presentation and group exercise

3. Key facts

Settling thickening tank is one of the essential components in the treatment facility for FSS as it reduces the hydraulic load on the subsequent solid handling treatment units and organic load on the liquid handling treatment units.

4. Learning notes

A good understanding of site specific FSS characteristics is required in order to determine the tank surface and the volume of the scum, supernatant, separation, and thickened sludge layers. An empirical estimation of settling ability for the specific FSS that the tank is being designed for needs to be determined for the adequate design of the tank. Preliminary laboratory analyses should be conducted on the FSS that is to be treated, especially in terms of settling ability, thickening ability, potential for scum accumulation and SS concentration. It is important to ensure that the FSS used for these tests is that which will actually be treated. For example, if there is an existing network of collection and transport companies with vacuum trucks, sludge should be sampled from the trucks as this is what will be discharged at the treatment plant.

The sludge volume index (SVI) is a laboratory method to empirically determine the settling ability of sludge based on the amount of suspended solids that settle out during a specified amount of time. With activated sludge, it is considered that ideal settling conditions are reached with SVI less than 100 mL/g SS. For FSS, the stability and origin also need to be taken into account.

5. Notes for trainer

This session is an exercise where the participants try to find a solution to the given scenario in the Workbook in the module. The design is based on the methodology described in “Faecal Sludge Management: System approach for implementation and operation”. The calculations shown in the exercise is the basic design approach and shall be appropriately adopted to design the settling thickening tanks from case to case basis.

6. Bibliography

1. STRANDE, L.; RONTELTAP, M.; BRDJANOVIC, D. (2014): Faecal Sludge Management - Systems Approach for Implementation and Operation. London: IWA Publishing URL
2. Kevin Tayler (2018): Faecal Sludge and Septage Treatment – A guide for Low and Middle Income Countries: Practical Action Publishing URL
3. Heins, U., Larmie, S.A., Strauss, M. (1998). Solids Separation and Pond Systems for the Treatment of Faecal Sludges in the Tropics – Lessons Learnt and Recommendations for Preliminary Design, EAWAG/SANDEC, Report No. 05/98.
4. Heins, U., Larmie, S.A., Strauss, M. (1999). Characteristics of faecal sludges and their solids-liquid separation. EAWAG/SANDEC: Janeiro.
5. Vonwiller, L. (2007) Monitoring of faecal sludge treatment plant Cambérène in Dakar. EAWAG, Dübendorf, Switzerland.wq

Session

10

Designing of Stabilization Unit: Anaerobic Digester

1. Session objectives

To understand the design procedure for anaerobic digester and to design the treatment unit for a case given in the workbook.

2. Session plan

Duration 45 -minutes

Activity	Time	Material/Method
Design of anaerobic digester	45 min	Powerpoint presentation and group exercise

3. Key facts

Faecal sludge is known to have higher content of slowly biodegradable COD. Hence, to stabilize (digest) these solids, anaerobic digester is used. Anaerobic digestion not only generates methane gas, but also reduces the volume of sludge and increases the dewaterability of the sludge.

4. Learning notes

Anaerobic digestion is of different types such as – (a) Psychrophilic, (b) Mesophilic and (c) Thermophilic. Mesophilic anaerobic digestion is appropriate for Indian context as it demands operating temperature of 20 OC – 40 OC with SRT of 20-30 days.

Anaerobic digestion takes place in four stages and a state of balance needs to be maintained in this process. The four stages of anaerobic digestion are – (1) Hydrolysis of slowly biodegradable contents such as fats, cellulose and proteins, (2) Acidogenesis, (3) Acetogenesis and (4) Methanogenesis. The second and third stage results into organic acids which lowers the pH of the reactor, however the fourth stage is sensitive to pH and slow. Hence, if there is an increase in production of acids, the pH lowers below the favorable limit and souring of digester takes place.

On the other hand, if organic loading is not maintained properly, then the microorganisms scavenge each other killing the activity rate of digester. In both cases, recommissioning of anaerobic digester may be needed.

5. Notes for trainer

This session is an exercise where the participants try to find a solution to the given scenario in the Workbook in the module. The design is based on the methodology described in “Decentralized Wastewater Treatment in Developing Countries” by Ludwig Sasse (1998). The calculations shown in the exercise is the basic design approach and shall be appropriately adopted to design the anaerobic digester from case to case basis.

6. Bibliography

1. STRANDE, L.; RONTELTAP, M.; BRDJANOVIC, D. (2014): Faecal Sludge Management - Systems Approach for Implementation and Operation. London: IWA Publishing URL
2. Kevin Tayler (2018): Faecal Sludge and Septage Treatment – A guide for Low and Middle Income Countries: Practical Action Publishing URL
3. Ludwig Sasse (1998): DEWATS Decentralized Wastewater Treatment in Developing Countries, BORDA URL

Session

11

Designing of Dewatering Unit: Unplanted Drying Bed

1. Session objectives

To understand the design procedure for unplanted drying beds and to design the treatment unit for a case given in the workbook.

2. Session plan

Duration- 45 min

Activity	Time	Material/Method
Design of unplanted drying beds	45 min	Powerpoint presentation and group exercise

3. Key facts

FSS has higher content of water. After settling thickening of the FSS, the thickened sludge still can have up to 90% water content. Hence for dewatering and drying of sludge, unplanted sludge drying beds are used. Unplanted drying beds are less resource intensive for operation and maintenance, however, required significantly larger area.

4. Learning notes

Unplanted sludge drying beds are constructed in multiple number) usually between 8-12 beds and are operated over a period of weeks before the dried solids are taken out from the bed. The sludge loading and drying cycle depends on the TSS content of the sludge and local climatic conditions such as temperature, humidity and air flow.

Most design guidelines for sludge drying beds specify the allowable solids loading on the bed in kilograms of total solids per square metre per year (kg TS/m² year). A solid loading rate of 120–150 kg dry solids/m² year for primary sewage-works sludge and 90–120 kg dry solids/m² year for sludge from humus tanks is recommended. These figures are intended for use in temperate climates. Referring to conditions in tropical countries, solid loading rates typically vary between 100 and 200 kg TS/m² year, while noting the possibility of achieving higher loading rates. In practice, various researchers have reported loading rates higher than 200 kg TS/m² year.

The height of solids on the surface of the beds should not be greater than 300 mm .As this slows the drying process significantly and inadequately dried sludge also does not ensure removal of pathogens by desiccation process.

5. Notes for trainer

This session is an exercise where the participants try to find a solution to the given scenario in the Workbook in the module. The design is based on the methodology described in “Faecal Sludge Management: System approach for implementation and operation”. The calculations shown in the exercise is the basic design approach and shall be appropriately adopted to design the unplanted drying beds from case to case basis.

6. Bibliography

1. STRANDE, L.; RONTELTAP, M.; BRDJANOVIC, D. (2014): Faecal Sludge Management - Systems Approach for Implementation and Operation. London: IWA Publishing URL
2. Kevin Tayler (2018): Faecal Sludge and Septage Treatment – A guide for Low and Middle Income Countries: Practical Action Publishing URL
3. Ludwig Sasse (1998): DEWATS Decentralized Wastewater Treatment in Developing Countries, BORDA URL
4. Tchobanoglous, G., Burton, F.L., Stensel, H.D. (2002). Wastewater Engineering: Treatment and Reuse, 4th edition / revised. McGraw-Hill Engineering and Computer Science Books.
5. Pescod, M. B. (1971). Sludge handling and disposal in tropical developing countries. Journal of Water Pollution and Control Federation 43(4), p. 555-570.

Session

12

Faecal Sludge & Septage Receiving Station

1. Session objectives

- Introduction of septage receiving station & their types
- Understanding the potential of septage receiving station for treatment

2. Session plan

Duration: 60 minutes

Activity	Time	Material/Method
Receiving Station	30 min	Powerpoint Presentation
Types of Receiving Station	30 min	Powerpoint Presentation

3. Key facts

The primary function of a receiving station is transfer of septage from hauler trucks, preliminary treatment of septage, storage and equalization of septage flows, etc. The overall receiving station design varies with the amount of septage to be received, design of the hauler truck, type of preliminary treatment to be provided, downstream treatment & ultimate disposal, and odour considerations.

4. Learning notes

1. Receiving Station

The basic aim of the receiving station is to reduce the impact & risk on the STP due to co-treatment of septage and sewage. The objectives of the receiving station are enabling safe transfer of septage from trucks to the STP, to control the O & M of the treatment plant, storage & equalization of septage flows, etc.

Following are the components of any receiving station:

- **Dumping Station:** The dumping station is the initial point of reception of the septage at receiving station.
- **Screening:** Septage will generally contain various forms of untreatable debris such as rags, plastics, sticks, stones, etc. Such debris is separated from the liquid septage by a coarse bar screen. The screen provides the initial pretreatment of septage in order to protect unit processes downstream.
- **Grit Removal:** In septage, grit consists of sand, gravel & food particles that become enmeshed in the lighter weight organic matter & grease.
- **Storage / Equalization:** Septage holding basins can be used to provide for storage, equalization, mixing & aeration of the septage prior to further treatment.
- **Odour Control:** Odour problems at the septage receiving stations can be solved by proper siting & existing technologies including chemical scrubbers, filters, combustion & biological processes.

Figure 27: Layout of the Dumping Station

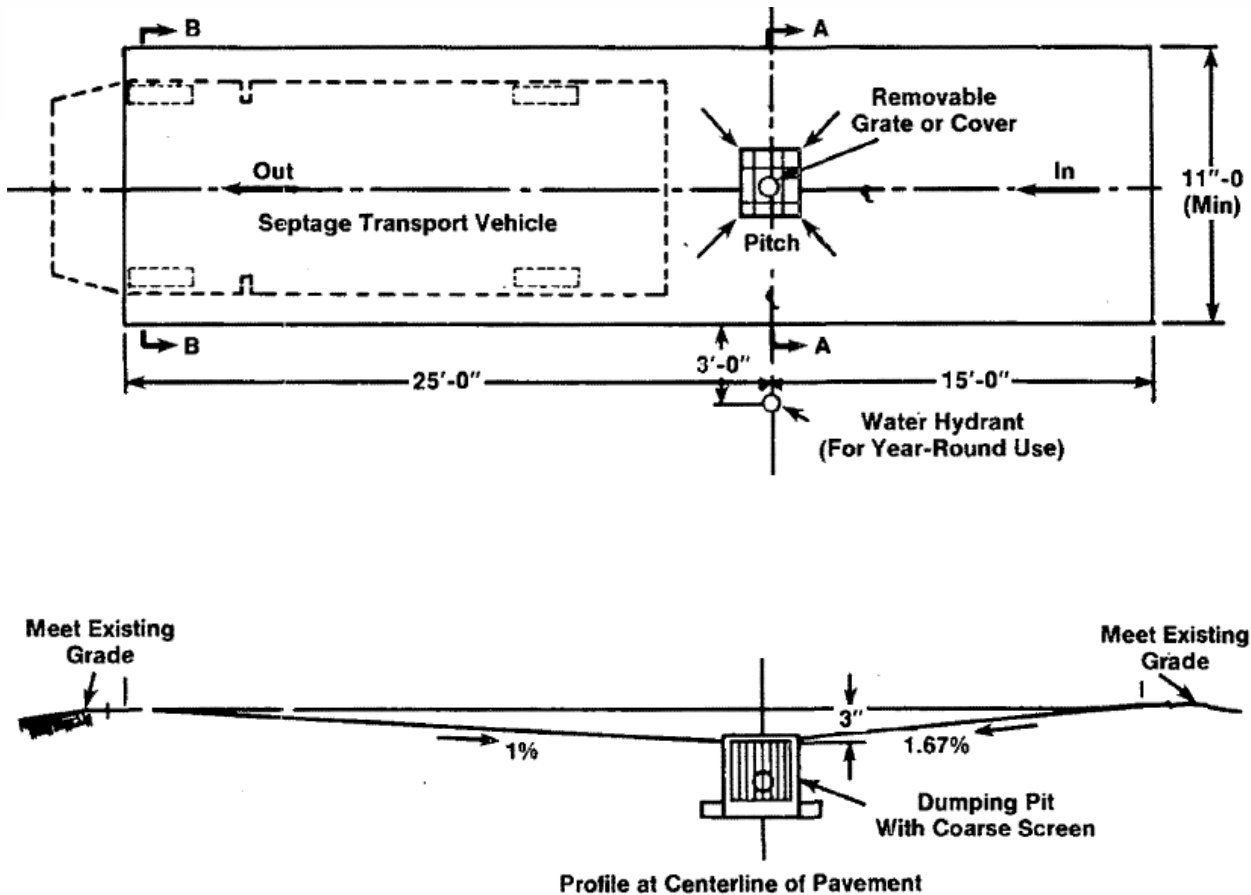

2. Types of Receiving Station

- Pre-Treatment at Headworks of STP:** Such receiving stations are designed where the headworks of the STP are well equipped with well unutilised. In such cases the main objective of the receiving station is to safely transfer the raw septage from the hauler trucks to the headworks in a controlled manner. Post which the raw septage will pass through screening, grit removal at the head works of the STP.
- Pre-Treatment before Equalization:** Such receiving stations are designed for handling smaller loads of raw septage. The receiving station is supposed to attain all the objectives i.e. safe transfer of raw septage, screening, degritting and controlled addition of the pre-treated septage into the headworks of the STP. An odour control system is optional, however, it is recommended to allot a space in the design so that in future it can be added. During the design of screens and grit chamber, one needs to understand how many trucks will be dumping the raw septage simultaneously and appropriately estimate the hydraulic peak flow. To avoid over design of the screening and grit chamber, such receiving stations are recommended for handling small loads.
- Pre-Treatment after Equalization:** These types of receiving stations are recommended where large quantities of septage needs to be handled. Cases where large quantities of the hauler trucks are going to empty the raw septage, it is logical to store the raw septage and then feed to the screen in a controlled manner. In this way the design of the subsequent treatment (screens and grit chamber) will be dependent on the max flow the pump output has. This also reduces O&M and malfunctioning of the screens and grit chamber. However, it has to be noted that the pump used here needs to be able to handle high amounts of grit (alternatively sludge pumps can also be used).

5. Notes for trainer

This session does not have group activity or discussion. However, this session becomes a base for understanding the septage receiving station. Hence, it is encouraged to have discussions on the local conditions and types & components of the septage receiving station if the participants have come across in the past.

6. Bibliography

1. STRANDE, L.; RONTELTAP, M.; BRDJANOVIC, D. (2014): Faecal Sludge Management - Systems Approach for Implementation and Operation. London: IWA Publishing URL
2. USEPA: Handbook on Septage Treatment and Disposal

Session

13

Preliminary Treatment of Faecal Sludge & Septage

1. Session objectives

To understand the preliminary treatment of faecal sludge & septage and understanding the mechanized equipment required for pre-treatment of septage

2. Session plan

Duration: 45 Minutes

Activity	Time	Material/Method
Screening	20 min	Powerpoint Presentation
Grit Removal	20 min	Powerpoint Presentation
Discussion	5 min	Discussion or Video

3. Key facts

Screening needs depend on both faecal sludge & septage composition & requirements of the subsequent treatment processes. The composition of material to be treated is strongly influenced by the toilet type.

Faecal sludge & septage may contain high concentrations of grit, particularly when removed from pits or tanks with unlined walls or floors. Because of the highly varying loading on faecal sludge & septage treatment plant, grit removal is not a simple task.

4. Learning notes

1. Screening

Coarse screening options include manually raked screens, rundown screens & various types of mechanical screens, some of which also remove grit. Design parameters for coarse screen include the approach velocity, the bar width & depth, the clear spacing between the bars, the screen angle to the horizontal & the allowable head loss to the screen whereas the bar screen design calculation should be based upon the peak flow generated when the tanker discharges.

It is recommended that the screenings be dewatered in order to facilitate handling prior to disposal. Smaller treatment plants receiving septage most often use a drained screw conveyor to transport screenings from the bar screen to a container for disposal. Presses designed for dewatering screenings are also commercially available. These presses have been used quite successfully on material from screens handling septage.

Figure 28: Design Criteria for Bar Screens (Source: Crites and Tchobanoglous, 1998)

Item	Unit	Manually cleaned	Mechanically cleaned
Bar width	mm	5–15	5–15
Bar depth	mm	25–40	25–40
Clear spacing between bars	mm	25–50	15–75
Angle to horizontal	degrees	45–60	60–90
Approach velocity	m/s	0.3–0.6	0.6–1
Allowable head loss	mm	150	150

Prefabricated Manual Screens

Manual screens are used for smaller receiving station. Usually these screens are developed for emptying on single truck at a time. It has a 4-6 inch quick disconnect fitting which eliminates

chances of spillage. The flow diverter is provided which eliminates any splashing of septage while emptying. Also, it even distributes the septage over the screen which eliminates the chances of choking of screen. The V shaped screen can accommodate higher flow and is easier to rake. The solid waste which is caught in the screen is raked manually into the channel which has holes in the bottom. Thus, the waste which is leaching septage will also get captured and is drained into the pan below. The solid waste then has to be pushed into a bin or wheelbarrow.

Figure 29: Picture of Prefabricated Manual Screens



(Source: Screencosystems)

Prefabricated Mechanical Screens

The mechanical screens are used where human intervention needs to be completely eliminated and higher flows need to be accommodated. A 4-6 inch quick disconnect fitting is provided which ensures there is no spillage. Stone and heavy object removal can be done however it is optional. This is followed by a shredder which shreds the solid waste such as rags, plastics etc to appropriate size. The mechanical drum ensures that all the solid waste is arrested and disposed into the screw conveyor which washes, compacts and transfers the waste to the bin or bag.

Figure 30: Picture of Prefabricated Mechanical Screens



(Source: WAM Group)

2. Grit Removal

The two-general type of grit chambers are the horizontal flow type & the aerated type. The horizontal flow type was more common in the past, but the aerated chambers are more effective in septage treatment applications. The grit removed from the septage can be handled in many ways. Grit is normally hauled to the dumping areas in trucks for which loading facilities are required. In larger plants, elevated grit storage facilities may be provided with bottom gates through which the trucks are loaded.

Parabolic grit channels

Longitudinal grit traps are used where high flows are expected. The septage after screening moves in the helical shape, as shown in the figure on the left. During this movement, the grit settles down in the channel provided below. Aerated grit chambers are also used to improve the separation of the grit from the septage. There is screw conveyor at the bottom which collects all the grit to one end of the grit chamber from where is removed, washed and dried before collecting in a bin.

Figure 31: Picture of Parabolic Grit Chamber

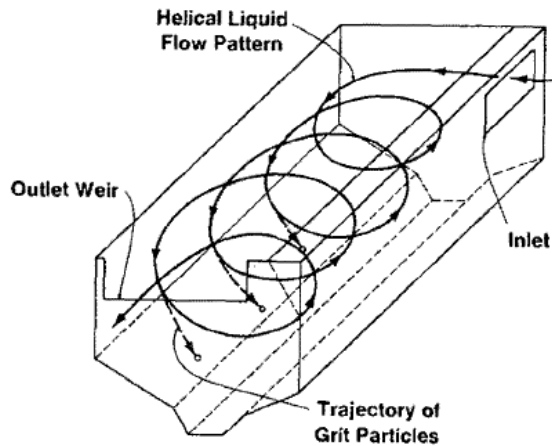

(Source: Huber Rotomat Ro6)

Figure 32: Vortex Separators (Huber Circular Grit Trap)

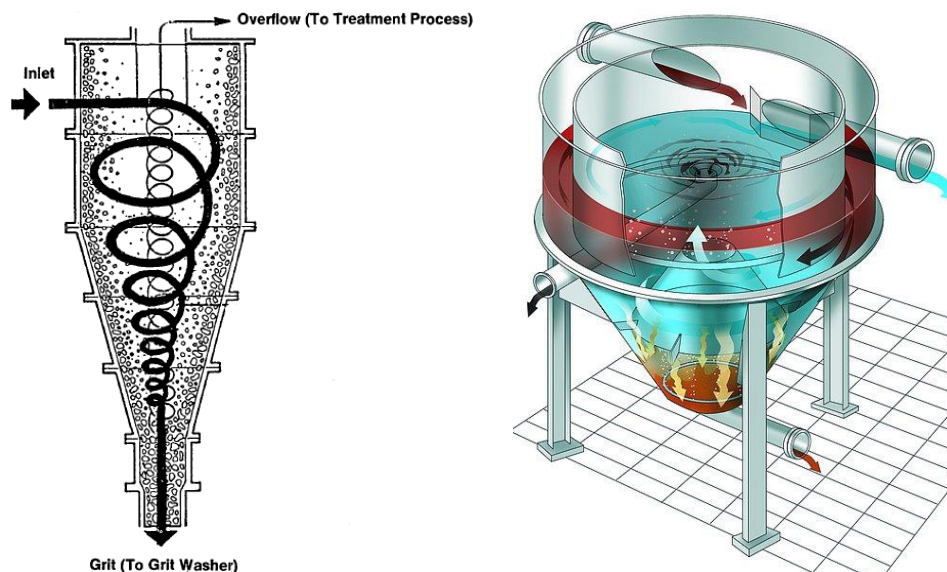

Vortex separators or Cyclone degritters are used where large volume needs to be treated and not much space is available. These degritters are vertical in shape and can be put underground too. However, in that extra screw conveyor is needed for removing the grit to the top or a pump is used. One more advantage of the cyclone degritters is that is can also separate oil, grease and fat from the septage. Cyclone degritters are becoming more and more popular due to their compact size.

5. Notes for trainer

This session does not have a group activity or discussion. However, this session becomes a base for understanding the preliminary treatment of faecal sludge & septage. Hence, it is encouraged to have discussions on the above topic. If time permits and depending upon the type of participants, trainers may choose to show video on preliminary treatment units of FSTP.

LINKS-

- WAM Group- The BEAST
- Mini Screen Receiving Station
- Parkson Combi Treatment & Septage Receiving Station
- Huber Complete Plant ROTAMAT Ro5

6. Bibliography

1. STRANDE, L.; RONTELTAP, M.; BRDJANOVIC, D. (2014): Faecal Sludge Management - Systems Approach for Implementation and Operation. London: IWA Publishing URL
2. USEPA: Handbook on Septage Treatment and Disposal
3. Kevin Tayler (2018): Faecal Sludge and Septage Treatment – A guide for Low and Middle Income Countries: Practical Action Publishing URL
4. Crites, R. and Tchobanoglous, G. (1998) Small and Decentralized Wastewater Management Systems, Boston, MA: WCB McGraw Hill.
5. Environmental Protection Agency (2005) Wastewater Treatment Manuals: Preliminary Treatment, Environmental Protection Agency Ireland, Ardvacan, Wexford URL

Session

14

Mechanized Dewatering Units

1. Session objectives

To understand the different mechanical dewatering equipment & how to choose the appropriate type based on the requirement

2. Session plan

Duration: 60 minutes

Activity	Time	Material/Method
Mechanized Dewatering Unit	40 min	Powerpoint Presentation
Group Exercise and Discussion	20 min	Group Exercise and Discussion

3. Key facts

Mechanical presses separate liquid from solids by applying pressure to the sludge to separate liquid & force the separated liquid through a filter or fine mesh which retains the dewatered sludge. The addition of chemical polymer upstream of the press is required to precondition the sludge & improve the dewatering effectiveness.

4. Learning notes

1. Mechanized Dewatering Units

Mechanized dewatering units have been used for dewatering of sewage sludge in the STP's. The mechanical dewatering units are mainly of two types: centrifuge & press. Mechanical centrifuge is quite efficient & mostly appropriate for STP, whereas the mechanical press is more suitable for faecal sludge & septage. The mechanical presses are of 3 types: screw press, belt press & frame press filter. Following table describes the brief difference between a screw press & a belt filter press:

Table 6: Mechanized Dewatering: Screw Press vs Belt Filter Press based on Operation

Technology	Operation	Maintenance
Screw press	<ul style="list-style-type: none">• Intermittent medium pressure wash water (<10% sludge flow rate at 4 bar pressure)• Simpler operation• Enclosure keeps surrounding environment clean and safe• Low Energy consumption	<ul style="list-style-type: none">• Fewer parts to monitor and maintain• Less inventory to maintain
Belt filter press	<ul style="list-style-type: none">• Continuous wash water (50-100% sludge flow rate at 8 bar pressure)• Unenclosed units are messy to operate and present a health hazard; however, allow visibility of process performance.	<ul style="list-style-type: none">• Simple equipment to maintain (rollers, bearing, belt)• More parts to monitor- inspect and maintain

Table 7: Mechanized Dewatering: Screw Press Vs Belt Filter Press based on Performance

Technology	Dewatering Performance	Cost
Screw press	<ul style="list-style-type: none"> • Can receive sludge with low solid content (<1%) • 15-25% final dry solids • Less sensitive to non-homogenous sludge characteristics 	<ul style="list-style-type: none"> • Higher capital costs • Slightly lower operation cost
Belt filter press	<ul style="list-style-type: none"> • Can receive sludge with solid content < 0.5% • 15-25% final dry solids • Can be provided with greater capacity for single unit 	<ul style="list-style-type: none"> • Lower capital cost • Slightly higher operating cost

2. Performance

The performance is highly dependent on the sludge characteristics and its dewaterability. Hence, polymer dosing is recommended to condition the sludge. Equipment characteristics such as type of belt and spacing of blades etc also have an impact on the dewatering efficiency. However, these are fixed by the manufacturers after performing research and development. Operation of the equipment refers to operational parameters such as pressure of the end plate or the compaction pressure in case of belt press. These parameters are variable and it is upto the operator to change depending upon the sludge characteristics.

The performance efficiency of the mechanical dewater equipment is quite high. It can remove up to 95% of the solid contained in the sludge if operated optimally. It needs to be kept in mind that dewaterability of the septage is quite high as compared to that of faecal sludge.

3. Operation and design considerations

It is always recommended to get in touch with an expert/manufacturer for the selection of proper equipment. Since there are specific design parameters which are fixed by manufacturers after performing research and development, it is wise to know these constraints before finalising the equipment for treatment. In most cases pre-treatment of sludge is recommended. Pre-treatment might consist of removal of grit and gross solids. Grit is responsible for wear and tear of the equipment. Gross solids might result in clogging or breakdown down of the equipment/pumps. Conditioning of polymer is also recommended so as to have solids concentration between 1-2% consistently to the dewatering equipment. All the dewatering equipment demand a reliable source of clean and pressurized water for washing the dewatering parts (casing, belt etc.).

Operation of the mechanical dewatering equipment demands continuous monitoring. Monitoring is needed to ensure proper conditioning of the sludge before it goes for dewatering. Also, it helps to have early detection of problems and maintain an inventory of consumables and spares of the equipment. Preventive maintenance is utmost important in case of mechanical equipment. Preventive maintenance helps to prevent the complete breakdown of the equipment. To carry out preventive maintenance, it is very important to have more than one equipment (if the equipment is needed on a daily basis and quite frequently). Area around the unit needs to be kept for movement of the mechanic and hauling of the parts etc.

There are certain environmental and health concerns which needs to be considered while selecting appropriate equipment. Screw press are quite compact and completely enclosed. Hence there are very few concerns pertaining to bio safety or odour. Belt press, however, is available with or without enclosure. Although, the press without enclosure is cheaper, allows easy inspection during its operation and facilitates access to parts during preventive maintenance; there are hazard related to odour, gases and pathogen.

5. Notes for trainer

This session consists of an exercise where the participants will try to find out the solution to the given scenario in the Workbook of the module. The calculations shown in the exercise is the basic design approach and shall be appropriately adopted to design the mechanized dewatering units from case to case basis. If time permits and depending upon the type of participants, trainers may choose to show video on preliminary treatment units of FSTP.

LINKS-

Screw press animation

Volute screw press

Working of a volute screw press

Belt filter press animation

Working of a belt filter press

6. Bibliography

1. STRANDE, L.; RONTELTAP, M.; BRDJANOVIC, D. (2014): Faecal Sludge Management - Systems Approach for Implementation and Operation. London: IWA Publishing URL
2. USEPA: Handbook on Septage Treatment and Disposal
3. Kevin Tayler (2018): Faecal Sludge and Septage Treatment – A guide for Low and Middle Income Countries: Practical Action Publishing URL
4. Gillette, R., Swanbank, S. and Overacre, R. (2009) Improved Efficiency of Dewatering Alternatives to Conventional Dewatering Technologies, 2009 PNCWA Webinar, Recent Developments in Biosolids Management Processes URL

Session

15

Mechanized Drying Units

1. Session objectives

To understand the different types of sludge drying equipments based on solar & thermal processes.

2. Session plan

Duration: 45 minutes

Activity	Time	Material/Method
Solar Drying	20 min	Powerpoint Presentation
Thermal Drying	20 min	Powerpoint Presentation
Discussion	5 min	Group Discussion or Video

3. Key facts

- There are two types of drying equipment available for drying of dewatered sludge- solar drying and thermal drying.
- Solar drying required more area as compared to thermal drying, however the energy required is significantly less.
- Thermal drying is more controllable as compared to solar drying, however it is more expensive for implementation and O&M.

4. Learning notes

1. Solar Drying

Figure 33: Schematic Diagram of Solar Drying

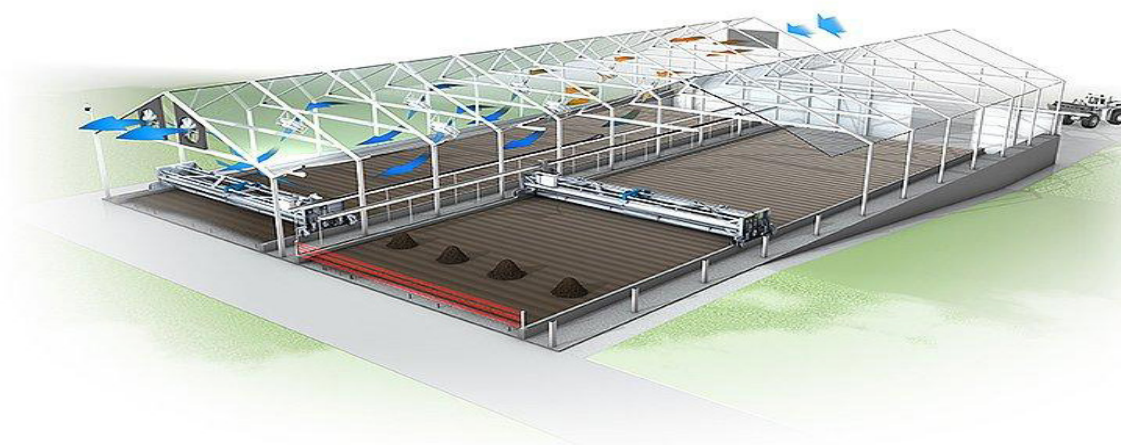

(Source: HUBER Solar Active Dryer SRT)

Solar drying is an option for increasing the solids content of the sludge to the levels required for some of the treatment options. It can also be used as a stand-alone sludge drying technology. Commercially available solar dryers may operate in either batch or continuous mode. The performance of solar sludge drying is dependent on solar radiation, air temperature, relative humidity of the air and depth of the sludge. The ventilation flux controls the relative humidity and accelerates the evaporation process of moisture from the sludge. The initial water content and depth of sludge also affects the performance of drying. To regulate the depth of sludge and to expose the maximum area of the sludge, tilling equipment is used, which tosses and turns the sludge while maintaining the height of the sludge and exposes it to the relatively dry air. In

practice it will be easier to determine solar drying bed requirements using information on drying rates or evaporation rates obtained from field studies.

Operational and design considerations

The drying cycle time of the sludge depends on the initial solid content, evaporation rate which is dependent on solar radiation, air temperature and ventilation rate and sludge depth. The sludge depth can vary from 150 – 400 mm. However, it is recommended to have tilling mechanisms for higher depths such as 250 mm. A ventilation rate of 150 m³ per square meter area of solar sludge drying house is recommended. However, it is completely dependent on the site conditions and should be adjusted accordingly.

2. Thermal Drying

Thermal drying involves heating of dewatered bio-solids to evaporate water & hence reduce their water content. In case of thermal dryer, the initial solid content should be approximately 60%. This is required so that the sludge moves through the dryer without sticking to the walls. The dried sludge in the end has a solid content of 90-95%. Thermal dryers fall into two basic categories- direct thermal dryers in which hot air is directly blown over the sludge and indirect thermal dryers in which the heat is transferred to the sludge from a heat transfer medium such as oil by conduction through the metal wall of the vessel holding the sludge. The most commonly used types of direct dryers are rotary & belt dryers. Indirect drying options include paddle dryers, vertical tray dryers & an indirect type of fluidized bed dryer.

Operational and design considerations

Thermal dryers have high energy requirements, since a tremendous amount of energy is required to heat the water and there by vaporise it. However, thermal dryer requires significantly less area for processing the sludge. In optimised operation, efficiency of the dryer is more than 80% consistently. Health and safety consideration such as production of dust should be taken into account. Operators need to be trained properly and persons with definite skills are required for operating such equipment.

A. Rotary Dryer

The simplest form of dryer is the direct rotary dryer. This consists of a cylindrical steel shell that rotates on bearings and which is mounted horizontally, with a slight slope down from the feed end to the discharge end. The feed sludge is mixed with hot gases produced in a furnace and is fed through the dryer. As it passes through the dryer, flights (fin-like attachments to the wall of the cylinder) pick up and drop the sludge, causing it to cascade through the gas stream. Moisture in the sludge evaporates, leaving a much dryer material at the discharge end of the dryer. The dried sludge is separated from the warm exhaust gas, part of which is recycled to the dryer while the remainder is treated to remove pollutants and is then vented to the atmosphere.

B. Belt Dryers

Belt dryers operate at lower temperatures than rotary drum dryers. The heat from the furnace is transferred to a thermal fluid, which heats the air in the dryer. The dewatered cake that is to be dried is distributed onto a slow-moving belt, which exposes a high surface area to the hot air.

C. Paddle Dryers

Paddle dryer has paddle wings which are hollow from inside so that steam can be circulated from it. The paddle system is also encompassed into a jacket which is fed by steam. When raw material is introduced into the paddle dryer, the heat is transferred from the paddles to the sludge. The sludge moves in the forward direction and get churned as it moves ahead. From the other end the

dried solids come out of the dryer. Dry air is introduced in the jacket to drive away the moisture laden air out of the dryer.

D. Fluidized Bed Dryer

The fluidised beds have been used for drying Europe and the USA since the 1940s to create pellets of sludge. In this case the medium (sand) is heated and kept in fluidised state by introducing hot air in the reactor. The wet sludge is introduced in to the reactor and flash drying takes place. The heated solids are then cooled using cool air before they are taken out of the reactor. Here cyclone de-gritters are used to remove the dust from the hot and cold air coming out of the reactor. Fluidised bed reactor is quite complex to operate and its energy requirement is high too.

5. Notes for trainer

This session does not have group activity or discussion. However, this session becomes a base for understanding the mechanized drying units. If time permits and depending upon the type of participants, trainers may choose to show video on preliminary treatment units of FSTP.

LINKS-

- Sludge solar dryer
- Rotary sludge dryer
- Belt sludge dryer
- Paddle sludge dryer
- Fluidised bed sludge dryer

6. Bibliography

1. STRANDE, L.; RONTELTAP, M.; BRDJANOVIC, D. (2014): Faecal Sludge Management - Systems Approach for Implementation and Operation. London: IWA Publishing URL
2. Kevin Tayler (2018): Faecal Sludge and Septage Treatment – A guide for Low and Middle Income Countries: Practical Action Publishing URL
3. Huber Technology (2013). Huber Solar Active Dryer SRT (PDF). Website www.huber-technology.com
4. Pescod, M. B. (1971). Sludge handling and disposal in tropical developing countries. Journal of Water Pollution and Control Federation 43(4), p. 555-570..

Session

16

Mechanized Thermal Treatment

1. Session objectives

To understand the different types of thermal treatment possible for faecal sludge & septage treatment.

2. Session plan

Duration: 45 minutes

Activity	Time	Material/Method
Incineration	20 min	Powerpoint Presentation
Pyrolysis	20 min	Powerpoint Presentation
Discussion	5 min	Group Discussion or Video

3. Key facts

Thermal treatment of sludge consists of incineration & pyrolysis of dewatered dried sludge. The sludge needs to be dried to increase the solid content to more than 60% for incineration. Higher the solid content, the better it is for combustion. This equipment does not have high CapEx & OpEx, however they provide significant bio safety & reduction in the volume of end product.

4. Learning notes

Thermal treatment of sludge can result in different types of intermediate products and end products. It depends on the process parameters and control of the process. The figure in the slide shows different kinds of processes and their products. Incineration and pyrolysis are few processes which have been tried and tested for managing faecal sludge and septage. Although there are different kinds of intermediate products possible, the ultimate aim is to recover heat or generate electricity from it. In some cases, nutrient recovery is also possible.

1. Incineration

Incineration refers to complete combustion of organic matter at high temperatures. Thus, resulting in the ash, which reduced the volume of sludge to 10% of its initial volume. Thus, incineration can be seen as a disposal mechanism for reducing the volume of end product to be disposed or to generate heat or electricity which can be used for various processes. The fly ash which is created as the end product can be used as a raw material for making bricks. Two different types of incinerators can be studied which are: Fluidized bed incinerator & Electric infrared furnace. In order to make the thermal drying self-powered through incineration of the dried sludge, the energy produced through incineration should be equal to or more than the energy required for drying of solids.

Energy content in the faecal sludge and septage is quite less as compared to sewage sludge and coal. Hence, faecal sludge alone cannot replace the fuels in the furnaces. It is better to have co-combustion with coal or different fuels such as wood etc. in cement and brick kilns. However, it needs to be noted that incineration is only possible when the dewatered sludge is dried with a solid content of up to 60% or more. Hence financial viability needs to be checked if the cost of drying the sludge for combustion is less than the financial gains envisioned from the extracted heat.

2. Pyrolysis

Pyrolysis is the thermal decomposition of material at high temperatures in the absence of oxygen. It may be classified as fast, intermediate or slow. Pyrolysis differs from combustion, in that little or no carbon dioxide is released during the process. Pyrolysis produces a mixture of gases that are used as a fuel to power the process. The high temperatures reached during pyrolysis completely remove pathogens, ensuring that the biochar produced is safe to use. Potential challenges include the difficulty of controlling emissions & the maintenance challenges arising from the nature of liquid produced during pyrolysis.

Pyrolysis refers to the stage which is intermediate to combustion. In an oxygen deficient environment and at a temperature around 200 – 500 °C pyrolysis takes place. The organic molecules in the sludge are chemically altered to yield carbon-based products such as biochar, oils and gases. These products can then be used as fuels for completing the combustion process.

Dry Pyrolysis

Dry pyrolysis refers to process which is taking place in dry environment. The sludge to be pyrolyzed needs to be dried to the solid content of more than 60%. This is required to avoid drop sudden drop of temperature in the pyrolyzer. The figure on the right shows the complete process from drying to pyrolysis in a skid mounted equipment. The dewatered sludge falls on the conveyor belt and is exposed to hot gases coming from the pyrolysis process. The hot air drives away the moisture and are treated before being released into the environment. The dried solids then fall into the pyrolyzer. In the pyrolyzer the dried sludge gets converted into a product called bio char which is a form of coal. The biochar is removed from the pyrolyzer using discharge screw. Thus, it can be seen that there is not physical handling of sludge involved making the complete process bio safe.

Figure 34: Schematic Diagram of Dry Pyrolysis System

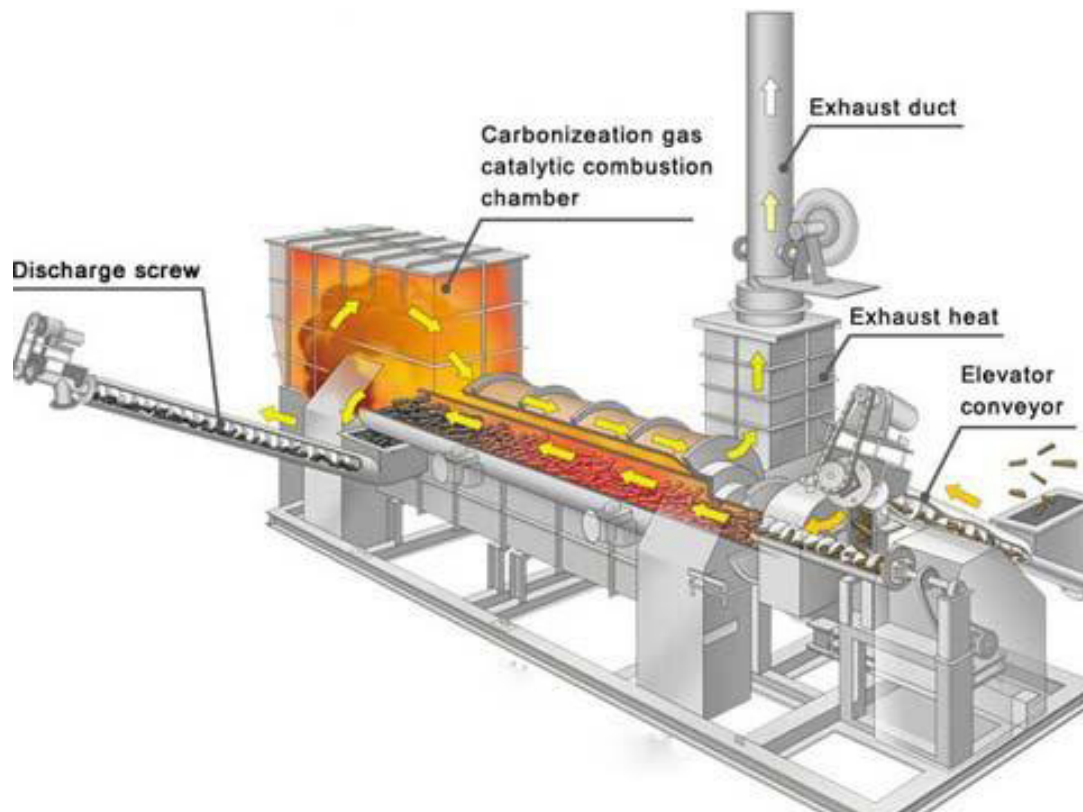

(Source: King Tiger Group)

Wet Pyrolysis

Hydrothermal carbonisation or wet pyrolysis is also one way of tackling dewatered sludge. In this process, the dewatered sludge is subjected to high pressure and temperature by introducing steam in the reactor. Due to the control parameters, the water reaches its critical stage and chemically alters the organic carbon in the solids. Although this process is termed as ineffective carbonization, but the end product is free from pathogens and rich in nutrients. The end product of the process known as hydro char can be used as a soil supplement to improve its fertility.

Figure 35: Representative Picture of Wet Pyrolysis of Hydro Thermal Carbonisation System



(Source: G8 International Trading Ltd.)

5. Notes for trainer

This session does not have group activity or discussion. However, this session becomes a base for understanding the mechanized thermal treatment & its types. If time permits and depending upon the type of participants, trainers may choose to show video on preliminary treatment units of FSTP.

Links –

- Incineration process animation
- Dry pyrolysis process animation
- Hydrothermal carbonisation

6. Bibliography

1. STRANDE, L.; RONTELTAP, M.; BRDJANOVIC, D. (2014): Faecal Sludge Management - Systems Approach for Implementation and Operation. London: IWA Publishing URL
2. Kevin Tayler (2018): Faecal Sludge and Septage Treatment – A guide for Low and Middle Income Countries: Practical Action Publishing URL

Session

17

Construction of Faecal Sludge & Septage Treatment Plant

1. Session objectives

To focus on softer aspects pertaining to implementation of Faecal Sludge Treatment Plant (FSTP) i.e. pre-construction documentation, supervision of construction, commissioning and handing over of the system

2. Session plan

Duration: 45 minutes

Activity	Time	Material/Method
Stages of construction of faecal sludge treatment plant (FSTP) Pre-construction	15 min	Powerpoint presentation
Quality Control	15 min	Powerpoint presentation
Commissioning	15 min	Powerpoint presentation

3. Key facts

- Contract documentation is important before starting the construction of the treatment facility.
- Site supervision is required for monitoring of the construction process and quality of it.
- Commissioning of treatment facility has multiple steps and might be a time consuming process, however it needs to be completed before introducing the waste and handing over.
- Handing over documents is an important link between the designer – contractor and the organization performing O&M of the plant.

4. Learning notes

1. Pre-construction Stage

Contract Documentation

It is an initial stage of construction of FSTP. Before awarding the contract of construction of treatment facility, there is need of preparation of contract document which has a clear definition of the duties, responsibilities and rights of the parties. There should be mention of accurate drawings and specifications of all the work. The contractor needs to go through the drawings, specification before signing the contract. Supervision of the contractor's work needs to be done by an experienced and knowledgeable staff from ULB or the consultant who prepared the DPR or the party who is responsible for O&M of the treatment plant.

Site Supervision

Site supervision should be undertaken by a project engineer who knows the project inside out and should be involved in the project since the beginning. Ideally the project manager should be appointed from the ULB staff, however, in cases where the ULB lacks the capacity, an external consultant can also be appointed. Inputs (pertaining to installation etc.) from the designer of the plant or the equipment manufacturer should be included in the job description of the project manager under the "special conditions of contract". A defect liability of at least 6 months should be provided by the manufacturer and the contractor.

2. Construction Stage and Quality Control

Sound Construction

The construction stage involves many challenges to override the process. It is important to follow few steps to accurate the construction work where contractors have to deal with quality of concrete and other material, corrosion of metal components, leak free construction etc.

Leak free construction is primary aim during construction of waste treatment plants. Especially in cases of liquid waste treatment facility, it is of utmost importance that there is no leakage. RCC tanks should be used for water retaining structures. Specifications as per the IS codes should be followed while constructing RCC structures. The structures should be tested for leakage before wet commissioning of the treatment plant. As a good practice of sound construction, concrete mix as specified by the structural consultant should be used. In cases where the concrete is prepared at the site, storage of the cement should be in correct manner on the crates in a completely dry place. It is recommended to take concrete samples in the form of cubes from each batch of concrete and send it for testing to check its strength. Samples of other material such as sand, gravels and bricks etc should be sent for testing from time to time. Such small activities ensure that there are no malpractices happening during construction compromising the durability of the construction. The treatment facility might have highly corrosive environment leading to rapid rusting and deterioration of the metal components. Hence, as a sound construction practice, it is recommended to use either galvanised steel components or coat the metal components with epoxy or bituminous paint. To avoid corrosion of the concrete of civil components, use of sulphate resistant cement is recommended.

Accurate Construction

Accuracy of the construction as per the drawings given in the DPR in of utmost importance. As shown in the following table, inaccurate construction may lead to operational issues.

**Figure 36:(A) Poor distribution of sludge over drying bed
(B) Unbalanced flow from clarifier (C) Poor slopes in the channel**



In the first picture it is clear that sludge in certain parts of the drying bed is dewatered and dried whereas most of the other parts are still having free water. This will not only clog certain parts early but also lead to odour of nuisance of mosquitoes. In the second picture the metal v notch of the clarifier is not levelled properly. As a result of this, the water overflows only from certain portion. This will lead to creation of dead zone affecting the operational volume of the clarifier.

Some good practices are shown as accurate construction is shown in the following table. Having a splash plate at the drying bed helps to avoid displacement of sand under the inlet and ensures

even distribution of sludge in the drying bed. The drying beds should have multiple inlets to avoid creation of dead zones. Use of theft proof safe covers as shown in the picture in the centre should be used. Such covers cannot be opened without specialised equipment. This also discourages theft of these metal covers which is one of the major problems in the treatment plants. U shaped vent pipes are installed on the top of the anaerobic chambers to avoid inflow of water into the reactor during rainfall or accidentally dropping something into the reacting.

Figure 37: (A) Splash plate (B) Manhole cover with bituminous coat (C) Vent pipe installation



Commissioning Plan

A commissioning plan is something which needs to be created by the contractor with the help of project manager at the end of the construction phase. This plan should contain the roles and responsibilities of different managers and engineers from the funding, engineering, supervising and O&M organization. It should contain a plan for pre commissioning checks, procedure for wet commissioning and performance tests. Typically, a commissioning plan will have Gantt charts with step by step process of inspection and testing plans and copy of inspection and testing checklists.

3. Commissioning Stage

Pre-commissioning Stage

In commissioning stage, we have to carry-out few initial pre-commissioning tests such as hydrostatic testing, mechanical equipment tests, electrical equipment tests and control equipment tests before wet commissioning.

Pre-commissioning tests - Hydrostatic testing

As a part of pre commissioning test, hydrostatic tests need to be carried out of various components of treatment plant. A hydrostatic testing helps to detect leakage in the plumbing of tanks. In this test the tanks and pipes are filled with water. In the case of tanks, the water level is marked and the level is observed after a stipulated time (24-48 hours). If there is a drop in water level, there is a leak in the tank. In case of pipes after filling them with water pressure is applied. The pressure is observed for few hours. If there is a drop-in pressure, this means there is a leak. If there are any leaks, they need to be detected and rectified before going ahead with wet commissioning.

Pre-commissioning tests – Mechanical equipment tests

Mechanical equipment such as pumps, motors, blowers, dewatering or drying units need to be thoroughly checked. Check should be done for any damage during installation, lubrication, clearances and alignment of drives. Earthing wires, trip wires, safety equipment etc should be checked. The on-off position of the valves needs to be checked. This needs to be done especially in case of pumps. If self-priming pumps are not used, priming needs to be done before wet commissioning.

Pre-commissioning tests – Electrical equipment tests

Electrical equipment tests refer to check of electrical integrity of the circuits. Earthing, insulation and leak needs to be checked. Voltage tests needs to be done as operating the equipment on wrong voltage will face operational difficulties during wet commissioning. Trip test refers to tripping of electrical circuit in case of leak or short circuit of electricity. In such cases the circuit breaker should get activated and trip the circuits to avoid overheating of equipment.

Pre-commissioning tests – Control equipment tests

Control equipment test refer to testing of all the sensors and transmitters. Completeness of installation with respect to casing and its integrity needs to be checked. The functional testing along with calibration needs to be carried out. PLC and SCADA logic need to be theoretically checked; however, the inter-dependencies of the processes and loops etc. need to check manually. Fault conditions should be simulated to check if the plant responds appropriately to the fault or not.

Wet Commissioning

Wet commissioning of the plant refers to the process, where in potable or service water is introduced in the treatment units and all the equipment is operated in practical limits for minimum duration of 48 hours. It is necessary that before conducting this process, all components of each sub-system to be fully pre commissioned. Strict monitoring protocol needs to be followed during wet commissioning of plants.

- Process timing, sequences and responses in all scenarios should be documented.
- In case of PLC or SCADA, all modes need to be checked and have to run on AUTO mode.
- Emergency shut down scenarios should also be simulated.
- Response to disruption in operating mode and across full design operating range

Tasks performed during wet commissioning are as follows;

- Adjust the equipment and control settings such as the level of water in the tanks etc.
- Operate the mechanical, electrical and control systems under process conditions i.e. operational range.
- Plant start up and shut down testing should be carried out as per the process.
- In case of safe shut down or maintenance procedure, isolation of equipment and its process needs to be checked.

Process Commissioning

After successful wet commissioning of the treatment facility, process commissioning needs to be performed. During process commissioning, introduction of liquid waste into the plant is done and biological treatment process is established and physical/chemical treatment processes are tested. Flow in various components, effluent quality, odour from reactors needs to be checked. With respect to electromechanical equipment, noise, vibration and power draw needs to be checked.

As an output of the process commissioning, standard operating procedures and O&M manuals are prepared. The document should contain list of control points for instruments and sensors. Alarm signal settings needs to be explicitly mentioned for emergency shut down of the plant.

Process performance test

A process performance test is carried out for 28 days after the process commissioning is successful. The aim of this test to demonstrate that the plant meets the output specifications set out in the contract by the designer. Certain parameters need to be monitored closely during performance

tests. These parameters should be tabulated and graphs should be plotted with respect to time for interpretation of results. Comparison of the results with guaranteed standards is done. SCADA output of detailing the process with alarms and responses of the instruments during the 48 hours should also be attached. The discussion over the performance of the plant and individual components such as dewatering, drying units etc should be made.

Handover documentation

The handing over documents are prepared and handed over to the organization responsible for O&M of the treatment facility. The handing over documentation should contain all the individual documents listed below. These documents might change depending upon the treatment technology and its operational processes.

- General introduction and process overview
- Unit process guidelines
- Standard operating procedures
- Functional description and specification
- PLC and SCADA manual
- Equipment O&M manuals
- Statutory certifications
- Warranty register
- Process performance test and commissioning report
- “As Constructed” drawings
- Asset registration
- Training documentation

5. Notes for trainer

This session does not contain any group activity; however, it is recommended to have a discussion with the participants on the stages of pre-construction, quality control tests and commissioning stages. It is important to address the challenges in accuracy of construction, commissioning stages processes.

6. Bibliography

1. CPHEEO, GoI (2013): Manual on Sewerage and Sewage Treatment Systems, Part A: Engineering, Part B: O&M, Part C: Management, 3rd Edition, Ministry of urban Development, Government of India.
<http://cpheeo.nic.in/Sewerage.aspx>
2. Kevin Tayler (2018): Faecal Sludge and Septage Treatment – A guide for Low and Middle Income Countries: Practical Action Publishing URL

Session

18

O & M of Faecal Sludge & Septage Treatment Plant

1. Session objectives

- To understand the operation & maintenance (O&M) and monitoring plans and its content for a faecal sludge and septage treatment plant.
- To understand what an operation & maintenance (O&M) and monitoring plan is and check its completeness before handing over.

2. Session plan

Duration: 60 minutes

Activity	Time	Material/Method
Integrating O&M with planning and designing	15 min	Powerpoint presentation
O&M Planning	15 min	Powerpoint presentation
Monitoring and record keeping	15 min	Powerpoint presentation
Discussions	15 min	Group Discussion

3. Key facts

- Considerations for O&M of the treatment facility starts from the designing and layout of the treatment facility.
- O&M plan is very important documents and needs to holistically cater to all the O&M tasks that need to be performed by the operator to keep the plant operational.
- Monitoring of the processes at the treatment facility help in early detection or completely avoid issues and challenges at the treatment facility.
- A team of people is required to run-operate & maintain the treatment facility, it cannot be run by an operator alone.

4. Learning notes

1. Integrating O&M with planning and designing

Operation and maintenance (O&M) considerations

The O&M considerations which need to be taken into account while designing and planning of faecal sludge and septage treatment plant are given as follows,

Availability of local resources- Spares and tools pertaining to the natural treatment units are easily available, however, this might not be true in the case of mechanized treatment units. Consumables such as polymer or hypochlorite etc. needs to be bought quite frequently and hence the availability of the same needs to be checked. Skilled and trained manpower for mechanized treatment units might not be available at all places. Local NABL accredited laboratory should be identified for monthly checking of samples to maintain the records. Local contracting firms should be identified especially for preventive maintenance of various electromechanical components such as pumps and other equipment.

Degree of mechanization: Mechanization of the operations at the treatment facility reduced the human contact with the sludge and hence is required. However, higher degree of mechanization demands, uninterrupted power supply and trained personnel for O&M of the plant. To optimize the operations at the treatment plant having higher and continuous load of sludge should think of

certain degree of mechanization. Ex. Raking and transport of the dried sludge from the unplanted sludge drying bed can be performed using machines instead of employing manual labors.

Receiving sludge at FSTP

Operations pertaining to receiving sludge at the facility needs to be thought about during the layout planning of the treatment facility. Especially in case of treatment facilities where higher number of trips of vehicles is expected, the layout of the plant should be well designed. In such cases, the receiving station should be located adjacent to the treatment facility or at the entrance of the plant. A drive through should be provided in such a way that vehicles do not have to reverse at receiving station. Approval and record keeping is a very important task at the receiving station and it can be time consuming too. Hence, this process can be mechanized by provided access cards to the vehicles which when tapped onto a reader fills in the details of the truck and its operator automatically. The sludge samples need to be checked before approving the vehicle to decant the vehicle. In absence of mechanization, a manifest form needs to be filled.

Figure 38: Manifest Form needs to be filled by desludging operator

Manifest Form		
Sludge / septage origin		
Name (Household unit owner)		
Address		
Date and time of collection		
Source and volume of sludge/septage		
Source	Check one	Volume (cubic metre)
Residential		
Commercial / industrial		
Institutional		
Wastewater treatment plant		
Commercial / industrial waste must be sampled and tested before it is offloaded at the treatment facility to ensure that the material will not contaminate the treatment process. Contamination can be caused by grease, oil, metals and chemicals.		
Description of commercial / industrial waste:		
Excavator / transporter		
Operator / company		
Address		
Type of vehicle		
Plate number		
Name of driver		
Signature		
Driver's license number		
Name of other personnel		
Approved by authorised representative		
(Name and signature)		

Considerations for O&M Plan

While preparing the O&M plan, the most important consideration is the type of desludging which is going to be adopted. In case of scheduled desludging the O&M tasks will have to frequently undertaken and hence in such cases, outsourcing of certain tasks such as preventive breakdown maintenance of pumps and other electro mechanical components can be done.

In case of demand desludging the O&M activities will have to be staggered depending upon the operations of the plant. Also, certain tasks pertaining to certain treatment units might decrease or increase.

2. O&M Planning

O&M plan content

The O&M plan should contain the details mentioned below,

- The engineering drawings and specification of all the treatment components installed at the treatment facility.
- In the case of electromechanical components, manufacturer's details along with the literature provided with the equipment and its operation guidelines should be attached.
- There are different types of people who will be working at the treatment facility such as Environmental/Civil Engineer, Head operator, Operator, Chemist, Lab assistant, Skilled labour etc.
- The list of tasks and person responsible for it should be clearly mentioned along with its frequency.
- Operation procedure and tools required to perform the task should be mentioned.
- Safety measure and use of appropriate PPE should be covered in the O&M plan.
- Information that needs to be monitored and logged into the operator's handbook should also be mentioned.
- **Chemicals and consumables:** O&M plan should consist of consumables such as chemicals their required quantities, name of the supplier and its specification. Storage details of these consumables should also be mentioned.
- In case of non-regular activities such as overhauling of dewatering equipment.
- The plan should also contain the steps that need to be taken in case of emergencies such as fire or medical emergency or natural calamity.

Maintenance procedures are of two types -Preventive maintenance and Breakdown maintenance.

- **Preventive maintenance-** It refers to the maintenance which needs to be carried out in order to reduce the likelihood of equipment failure. It needs to be performed when the equipment is still functional so that it does not breakdown unexpectedly causing disruption of the operations. Ex. Applying grease to the moving mechanical parts to reduce the wear and tear or over heating of the equipment.
- **Breakdown maintenance-** It refers to the repairs that need to be carried out to make the equipment functional after its breakdown.

Maintenance Procedures

The maintenance procedure sheets should be prepared for each treatment unit and should consist of all the information mentioned below,

- The list of tasks which need to be performed for complete maintenance of the unit.
- The frequency of the action, certain activities such as oiling and greasing might have to be done on a weekly basis whereas checking of overhauling of the equipment needs to be done in each quarter.
- Tools required for performing the tasks needs to be mentioned clearly.
- A step by step procedure to do the task needs to be mentioned.
- Exactly what needs to be inspected and what does the situation means should be checked and recorded into the log book.

Table :8 Operation and Maintenance Data Sheet Example

Task: Cleaning of Bar Screen	
Frequency	After stipulated number of dumping cycle
Tools	Screen raking rod and appropriate PPE Gum boots, Gloves, Helmet
Procedure	<ul style="list-style-type: none"> • Stand on the raking platform. Make sure that you are comfortable and stable. • Use the raking rod to rake the screen- starting from the bottom to the top. • Push the screenings onto the slotted part of the platform and allow the water to drip back into the screen channel. • Once the dripping stops, push the screenings into the tipper or bin • Clean the raking rod with water using the water hose before storing back • Once the bin is full, dispose off the screenings properly.
Inspection	Inspect the raking rod and PPE before starting the task

Other regular maintenance activities

Other regular maintenance activities at the faecal sludge and septage treatment plant can be cleaning of spillages at the septage receiving station .This should be done immediately after the spillage before continuing for decanting another vehicle .Removal of scum layer at the settling thickening tank needs to be carried out on a weekly basis depending upon accumulation on the scum in the tank .Measurement of the depth of the sludge in settling thickening tank needs to be done on a daily basis or weekly basis depending on its operation cycle and incoming load of sludge .However ,in the case of digesters ,the measurement of the depth can be done on half yearly basis.

Asset Management

All the electromechanical components such as dewatering or drying equipment etc can be termed as asset for the treatment facility and needs special attention to avoid breakdown. Asset management refers to the management of these electromechanical units. An asset management plan should contain all the information its cost and installation procedure. If any special specific spare parts which might require longer time to procure or costly should be known to the operator. The tools and supplies required to carry out the maintenance should be stored separately. Replacement cost of spares should also be indicated so that the operator can plan for the expenses in advance.

3. Monitoring and record keeping

Monitoring

The key objective of the monitoring at the treatment plant is to understand the treatment process and performance of the treatment units. Monitoring also serves as an early detection of any issue or failure. Monitoring plan with appropriate infrastructure, equipment in the laboratory, skilled personnel and finance. Different methods of monitoring are visual or sensory (odour) inputs, field (on site) testing or elaborate analysis in the laboratory.

- Monitoring based on sensory and visual inputs is required in case of daily checks. This needs to be done usually for valves and sensors which might be used in case of PLC and SCADA.
- On site testing using field equipment is necessary at the receiving station for granting approval for decanting the vehicle at the treatment facility.
- Checks such as colour, odour, temperature, pH and electrical conductivity is sufficient to differentiate between domestic and industrial sludge. Laboratory tests are recommended for checking the performance of the treatment units and can be performed on a weekly basis.

Chain of Custody

Chain of custody is a method which is used while performing sampling of influent and effluent for different treatment units. The custody forms contain all the necessary information regarding the samples. It also contains instructions for laboratory personnel, which might be useful for analysis of the samples. If the custody of the samples is given to another person, then this form becomes important as it ensures there is no loss of information between the person taking samples and the person analysing the samples in the laboratory.

Analysis Manual

It is recommended that either a manual should be prepared specifically for the lab at the treatment facility or at least a manual prepared by experts should be followed. Such manuals contain information regarding sampling, its storage, preservation, transport and protocols to conduct tests. It should also contain information regarding the calibration and maintenance of the equipment used in the laboratory. Quality assurance and quality control plan should be available for sampling. Sampling is a very important stage in monitoring and a small mistake during this stage can significantly affect the analysis and thereby the inferences drawn from the results.

Figure 39: Chain of Custody Form (Example)

Pat-Chem Laboratories 1824 1st Street San Fernando, CA 91340		CHAIN OF CUSTODY RECORD Phone (818) 639-5300 Fax (818) 639-5306				Environmental Sample Sample I.D.#: _____			
Customer: _____					Project: _____				
Address: _____					Sampled by: _____			P.O. #: _____	
Report Attention: _____					Phone #: _____				
Sample Description	Date Sampled	Time Sampled	# of bottles	Required Tests	Sample Type	Matrix	Bottle Type	Preserve	Field Data (pH / Temperature) pH: <u>Field</u> <u>Lab</u>
Signature	Print Name (Company)	Date	Time	Sample Received Checklist		Sample Type	Preservations		
Relinquished by				Temperature upon receipt: _____		Grab	HC - HCl		
Received by				# of bottles agrees with COC? Yes No		Comp	HS - H ₂ SO ₄		
Relinquished by				Samples intact? Yes No		Matrix	HN - HNO ₃		
Received by				Samples properly preserved? Yes No		AQ - Water	HP - H ₃ PO ₄		
Relinquished by				Samples in holding time? Yes No		SO - Soil / Sludge	OH - NaOH		
Received in lab by				Compliance Monitor		OT - Other	ST - Sodium Thiosulfate		
				Initial Flow _____		Bottle Type	AA - Ascorbic Acid		
				Final Flow _____		P - Plastic	AI - AlCl ₃		
						G - Amber Glass	Cu - CuSO ₄		
						VOA - 40 ml Vial			
						Coli - bacteria			

Note: Samples are discarded 30 days after results are reported, unless other arrangements are made.

Rev 2 Effective 6/1/17

Record Keeping

Record keeping is a part of monitoring activity. Record keeping is in different forms and might have to be done by different persons. For example, the operator’s logbook needs to be maintained by one or more operators appointed at the treatment facility. The reception log book should be

maintained by the receptionist at the septage receiving station. Disaster or emergency response record helps to record the accidents happened at the facilities. These are required in case the facility goes for ISO certification. The preventive and corrective maintenance records are kept for electromechanical components to understand the right time to place orders for spares etc. Compliance reports are necessary and are to be produced in the case to pollution control board from time to time.

Such record keeping helps to trace the issues, challenges and solutions for overcoming them. This documentation becomes of utmost importance, then the operators are changed during shifts or O&M contract is awarded to the new party.

5. Notes for trainer

This session does not contain any group activity; however, it is recommended to have a discussion with the participants on integrating O&M with planning and design, asset management, monitoring and record keeping at the faecal sludge treatment plant (FSTP) site.

6. Bibliography

1. STRANDE, L.; RONTELTAP, M.; BRDJANOVIC, D. (2014): Faecal Sludge Management - Systems Approach for Implementation and Operation. London: IWA Publishing URL
2. CPHEEO, GoI (2013): Manual on Sewerage and Sewage Treatment Systems, Part A: Engineering, Part B: O&M, Part C: Management, 3rd Edition, Ministry of urban Development, Government of India.
<http://cpheeo.nic.in/Sewerage.aspx>
3. Kevin Tayler (2018): Faecal Sludge and Septage Treatment – A guide for Low and Middle Income Countries: Practical Action Publishing URL
4. Bräustetter, A. (2007). Operation and maintenance of resource-oriented sanitation systems in peri-urban areas. Fakultät Umweltsicherung, Fachhochschule Weihenstephan Master.
5. HPCIDBC (2011). Status and Strategy for Faecal Sludge Management in the Kathmandu Valley. High Powered Committee for Integrated Development of the Bagmati Civilization, Nepal.

Session

19

**Siting, Layout Planning
& Safety Planning of
Faecal Sludge & Septage
Treatment Plant**

1. Session objectives

- To understand the method to identify options for sites for setting up treatment plant facility and an approach to finalize the suitable site for the FSTP
- To introduce to the participants the importance of layout planning of the FSTP.
- To introduce to the participants various safety planning aspects to be taken into considerations while planning a treatment plant for FSS.

2. Session plan

Duration- 45 minutes

Activity	Time	Material/Method
Siting of FSTP	5 min	Powerpoint presentation
Layout planning	10 min	Powerpoint presentation
Safety planning	5 min	Powerpoint presentation and discussions
Group exercise	25 min	Group exercise. Material to be provided separately by the trainers.

3. Key facts



- Siting of the plant affects the financial viability and sustainability of the project.
- Proper layout planning reduces the capital and operational expenditure significantly.
- Layout planning is also important for ease of operation and maintenance of the treatment units.
- Safety measures are of utmost importance at waste treatment facility and can be catered to by small cost when compared to the total project cost.

4. Learning notes

1. Siting of FSTP

Identification of the treatment sites

Table :9 Consideration for Identification of Treatment Sites

		
Desludging operators	Municipal authorities	Endusers
Discharge sites Hauling distance High demand of desludging	Municipality owned/reserved land	Agriculture Industry SWM plants Hauling of the end products Pricing of the end products

To identify options for treatment sites, there are a few points that one needs to take into consideration; Distance of the plant, Cost of land and Distance for end use/disposal of the treatment products. However, the common point is that all the three considerations affects the

life cycle cost of the project. To get insights into the appropriate location for the treatment facility, structured interviews with the desludging operators, municipal authorities and end users of the treated product needs to undertake.

Site selection criteria

The list of criteria and essential conditions for each criterion. The list has been compiled after referring to different site selection criteria laid down for siting of STPs in India. It should be noted that the criteria are not prioritised and that depending upon the situation certain criteria might weigh more important than the other.

Table :10 Site Selection Criteria

No.	Criteria	Essential conditions
1.	Average transport distance for mechanical service provider	Acceptability and affordability for service provider
2.	Accessibility	Ease of access
3.	Surface area	Surface area > 0.3 ha
4.	Land ownership and price	Guarantee to be able to buy, at a reasonable price
5.	Neighbourhood/potential for urbanisation	Risk of future access due to urbanisation
6.	Topography	No risk of flooding
7.	Soil type	Free soil (unconsolidated)
8.	Groundwater table	> 2m deep
9.	Opportunities for disposal of treated effluent and sludge	Must have disposal and endures possibilities

Characterisation and evaluation

In order to finalise the site, characterisation and evaluation of all the possible options needs to be conducted. Hence, points such as proximity to the neighbourhood, acceptance as well as proximity to the farmlands where the biosolids and treated water can be safely reused. Soil type and characteristic of the strata at the site affects the construction cost. A rocky strata or soft strata is unfavourable as it increases the cost of structural components in the capital cost of the project. Since most of the tanks are located underground at the treatment facility, groundwater table along with its content needs to be checked. Presence of sulphates in the soil and chances of leakages and contamination needs to be assessed.

Table :11 Characterization and Evaluation of Treatment Site Location

No.	Criteria	Essential check
1.	Neighbourhood- nuisance	Bad odour, Appropriate distances from the residential areas, City development
2.	Neighbourhood- synergy	Farm lands will promote the use of biosolids as well as treated water
3.	Soil type	Cost of excavation, Consult the local residents
4.	Groundwater table	Affects the lifetime of concrete, check nearby wells, consult the local residents

4.2 Layout planning

Layout planning is important as its development contributes to up to 50% of the total project cost. Cost of development of paved surfaces and green spaces at the treatment facility incurs considerable cost in the project. Hence, brainstorming to optimise the layout of the treatment facility is needed. Proper planning not only ensures smooth operations, but also eases the maintenance activities. In short, layout planning affects the sustainability of the project.

Considerations for Layout Planning

Considerations for layout planning are; Topography, Discharge point, Access to treatment units and wind direction. While planning the layout of the treatment facility, the advantage of the topography should be taken as much as possible. This reduces the requirement of pumping and hence reduces the operation cost significantly in the future. The storage of the treated products should be as close as possible to the discharge point. Access to treatment units such as sludge drying beds is very important for its operation and maintenance. Since these units are quite large, if not arranged well can lead to escalation in the capital cost of the project. Lastly wind direction is important in case of drying beds and solar drying beds. Also, wind direction becomes important in case of open ponds or tanks where odour and vectors can be a nuisance.

Table :12 Considerations of Layout Planning

Receiving Stations	
<p>Figure 40: Clear access to the receiving station. Easy manoeuvring of trucks pre and post decanting</p> 	<p>Figure 41: No splashing / spillage during decanting</p> 
<p>Figure 42: Receiving Station With Hose Pipe. Reduces The Time Taken To Decant With Minimum Spillage</p> 	<p>Figure 43: Access To Water in Case of Spillage Or Cleaning Of Screens</p> 

Screens

Figure 44: Inclined screens | Perforated tough | Access for operator to rake the screens



Figure 45: Poorly Designed Screens



Figure 46: Screen Basket Without Adequate Access



Figure 47: Enclosed Screen With Potential Hazard of Gases



Tanks and Ponds

Figure 48: Safety rails | Easy access by road / pathway | Easy access to valves and pipes



Sludge Drying Beds

Figure 49: Proper Layout Planning of Sludge Drying Beds



Access to sludge drying beds by appropriately wide roads

Use of hauling equipment for removing dried sludge

Ease of operation and maintenance tasks

Provision of cover for drying beds

Figure 50: Easy Access To Valves From Outside Of The Bed



Figure 51: Use of Splash Plate To Reduce Erosion And Even Spreading of Sludge And Flange Joints For Easy O&M



Constructed Wetlands

Figure 52: Importance Of Length to Width Ratio, Ease Of Use of Equipment



Good Practices

Figure 53: Constructed Wetlands with access by roads



Poor Access to Tanks ,Beds and Valves

Figure 54: Poor Access to Tanks, Beds and Valves



Mechanical Equipments

**Figure 55: Mechanical Equipments at Site
(Example of Ergonomics)**



In case of mechanical equipment, it is recommended to locate them inside the enclosed premise such as building or a shed. It should be kept in mind that there should be good access road with minimum width of 3.5 m road to the enclosure. The enclosure should have a large door so that forklifts etc can be used for installation of these equipment.

Ergonomically space should be kept around all sides of the equipment so as to ease the movement of the person while performing the O&M of the equipment. Electrical wiring for the electromechanical components should be inside the plastic conduits attached to the wall.

Sludge Storage Yard

Figure 56: Layout of Storage Yard



Sludge storage yard should have access via road with minimum width of 3.5 m. This eases the access and hauling of biosolids for use/discharge outside the plant. Adequate area should be planned so that the solids can be stored for a couple of weeks. Sludge storage yards should be well ventilated and should have transparent covers so as to allow sunlight to pass through it.

Other Components - Operator's room and Laboratory, Parking, Paved Roads and Storm water drains

Figure 57: Good access with paved road. Plant should be visible. Access to fresh water and electricity



Figure 58: Adequate parking with good access by wide paved road Provision of storm water drains



3. Safety planning

Safety Measures

- Fencing and compound wall should be of appropriate height. In case of mechanized treatment plant, barbed wires with CCTV cameras are also recommended.
- In cases of anaerobic digesters, enclosed spaces where accumulation of gases might take place should be avoided. Entry to such space should be restricted and appropriate signage should be installed.
- Safety measures such as proper installation of electrical wires and fixing of rails for tanks ponds a higher storey should be practiced. The installations should be made in such a way that they are durable.
- Electrical wires should run through casing either concealed or properly clipped to the wall Railing, raised walls with minimum height of 1.2 m should be provided around tanks and ponds
- Anti-slip surfaces should be installed at the staircases and ramps. Rubber mats should be placed near the electromechanical components, where the operator will stand while operating the equipment. This eliminates the risk of electrical shocks significantly.
- Warning signage needs to be put up at places like ponds, storage yard and tanks. This reduces the probability of the accidents caused by ignorance of labour staff working at the plant and public visiting the plant.

Personal Protective Equipment (PPE)

Personal Protective Equipment (PPE) is one of the very important measures when it comes to handling and management of waste (liquid/solid). Especially in case of FSTP where the pathogens are quite strong and sustainable, extra precautions need to be taken. Different PPEs are recommended when conducting various tasks for operation and maintenance as like performing day to day operations, decanting the trucks, ranking of screens, removing of dried sludge, performing maintenance tasks, overhauling of equipment etc. Examples of the same are given below,

Figure 59: Personal Protective Equipments (PPEs)



5. Notes for trainer

In this session, there is a group activity pertaining to layout planning. Multiple groups will be created based on the scenarios they have received of the Workbook provided with this module.

Depending on the scenario which the group has chosen, the groups will be given demarcated piece of land with various boundary constraints. Groups will also be provided with cutouts of the treatment units which they will have to arrange depending upon the site conditions. The group has to finalize all the various non treatment components which one may find at the FSTP such as parking lot, office roads etc. These components can be cut out from the sheets provided or marked by markers on the base sheet. The pool of trainers will support and help the participants during the exercise and clear their doubts.

In the end, each group showcases the layout plans they have created. The trainers will evaluate and give inputs to the groups on the layout plan.

6. Bibliography

1. STRANDE, L.; RONTELTAP, M.; BRDJANOVIC, D. (2014): Faecal Sludge Management - Systems Approach for Implementation and Operation. London: IWA Publishing URL.
2. AECOM and SANDEC/EAWAG (2010), A Rapid Assessment of Septage Management in Asia: Policies and Practices in India, Indonesia, Malaysia, the Philippines, Sri Lanka, Thailand and Vietnam, USAID, Bangkok, Thailand.
3. LUETHI, C.; MOREL, A.; TILLEY, E.; ULRICH, L. (2011): Community-Led Urban Environmental Sanitation Planning (CLUES). Dubendorf: Swiss Federal Institute of Aquatic Science and Technology (Eawag). URL.
4. PARKINSON, J.; LUETHI, C.; WALTHER, D.; IWA (Editor); GIZ (Editor); Eawag-Sandec (Editor) (2014): Sanitation 21. A Planning Framework for Improving City-wide Sanitation Services. London: International Water Association (IWA). PDF
5. Klingel F., Montangero, A. Kone, D. Strauss, M (2002): Faecal Sludge Management in Developing Countries – A Planning Manual, EAWAG/SANDEC
6. Emergency Response Sanitation Unit (ESRU), An Advisory on technical and managerial interventions for ensuring safety during sewer cleaning and septic tank cleaning, CPHEEO and MoHUA, GoI, 2019

Session

20

Liquid Effluent Treatment of Faecal Sludge & Septage Treatment Plant

1. Session objectives

- To understand the purpose and goal of wastewater treatment ,basics of wastewater treatment as design parameters and treatment process involved in the treatment systems.
- To understand the treatment chain and different aspects involved in the treatment stages of the system (Primary Treatment, Secondary Treatment and Tertiary treatment)

2. Session plan

Duration: 45 minutes

Activity	Time	Material/Method
Wastewater Treatment Basics	10 min	Powerpoint presentation
Wastewater Treatment Chain <ul style="list-style-type: none">• Primary Treatment• Secondary Treatment• Tertiary Treatment	30 min	Powerpoint presentation
Discussion	5 min	Group Discussion.

3. Key facts

- The purpose and goal of treatment of wastewater should be clear before considering different options for treatment.
- Wastewater treatment technologies consist of different components whose design needs to be individually tweaked for liquid effluent from FSTP.
- Nitrification, denitrification and aerobic treatment is needed order to achieve standards of treatment.

4. Learning notes

Purpose and Goal of Liquid Treatment

The ultimate aim of wastewater treatment is to reduce the quantity of pollutants entering the natural environment, in some cases the specific goals can change from case to case. Specific goals of wastewater treatment can be as follows;

- To supply water to the industry such as cement, pipe manufacturing, stone cutting or thermal power plant as process water,
- To reduce the eutrophication of the surface water bodies such as lakes,
- To reduce the dependency on the rain and irrigation canal water by reuse in agriculture in drought prone areas,
- To improve the ground water table through indirect aquifer recharge techniques.

4.1 Treatment Processes

Wastewater treatment processes are of different types- Physical, Biological, Chemical and P Photolytic.

- **Physical processes** are based on the physical characteristics of the wastewater constituents. Mainly it's the specific gravity of the constituent which assists the separation from the water. Most of these methods are based on physical forces, e.g. screening, mixing, flocculation, sedimentation, flotation, and filtration.
- **Biological processes** rely on microorganisms to carry out digestion of the organic matter

in anaerobic or aerobic conditions. Biological processes are the main heart and soul of any wastewater treatment plant.

- **Chemical processes** rely on the use of chemicals either to treat the water (e.g. Ozonation- to kill pathogens) or to assist the physical or biological processes (e.g. Alum or ferric chloride to coagulate the sludge).
- **Photolytic processes** rely on the photon in the light to treat the wastewater directly (e.g. UV to kill pathogens) or indirectly (e.g. Photosynthesis help to uptake the nutrients from the wastewater in case of constructed wetlands).

Design Parameters

The different type of design parameters used to design wastewater treatment units. The importance of few design parameters may increase or decrease from case to case basis.

- Organic loading (kg BOD/d, kg COD/d),
- Volumetric loading rate (m³/d)
- Temperature (oC)
- Hydraulic retention time (HRT) (hours or days)
- Sludge age (d)
- Biomass yield (kg VSS/ kg COD)
- Up flow velocity (m/s)
- Specific surface area (m²/m³)

2. Wastewater Treatment Chain

A waste treatment facility consists of different treatment stages combining different treatment processes. In the case of wastewater treatment plant, after the preliminary treatment i.e. screening; the wastewater undergoes treatment in primary stage. In primary stage, the physical treatment processes are used to remove the easily settleable solids usually known as grit. The units which provide primary treatment are listed in the slide above. In secondary stage, biological treatment processes remove the BOD and COD using the digestion process carried out by anaerobic and aerobic microorganisms. In the tertiary stage, chemical or photolytic treatment process is used to disinfect the wastewater.

Figure 60: Wastewater Treatment Chain

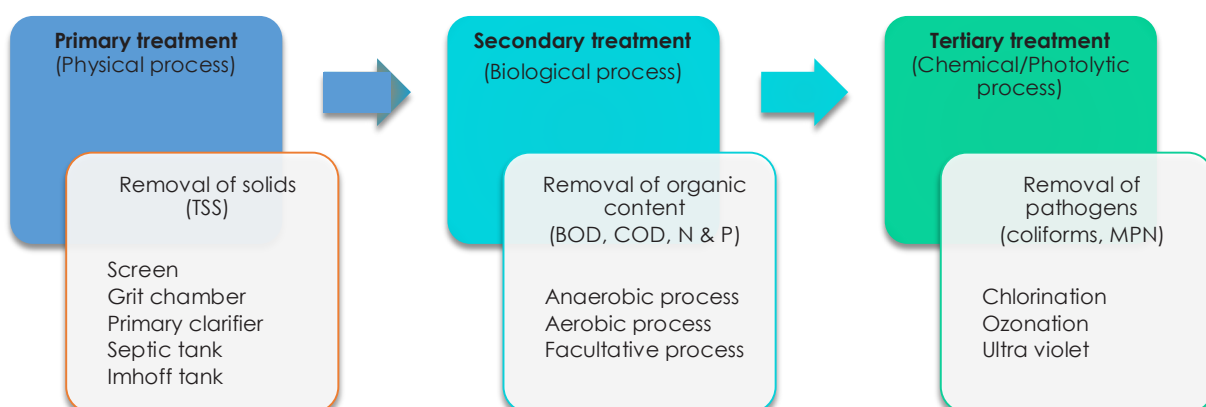

Primary Treatment

A. Screens

Screening aims to prevent coarse solids, such as plastics, rags and other trash, from entering a sewerage system or treatment plant. Solids get trapped by inclined screens or bar racks. The spacing between the bars usually is 15 to 40 mm, depending on cleaning patterns. Screens can be cleaned by hand or mechanically raked. The latter allows for a more frequent solids removal and, correspondingly, a smaller design. The screening may consist of parallel bars, rods, gratings or wire mesh or perforated plates and the openings may be of any shape, although generally they are contrived from circular or rectangular bars. It is recommended that three sequential stages of screens shall be provided being coarse, followed by medium and followed by fine screens

Figure :61 Schematic diagram of screens

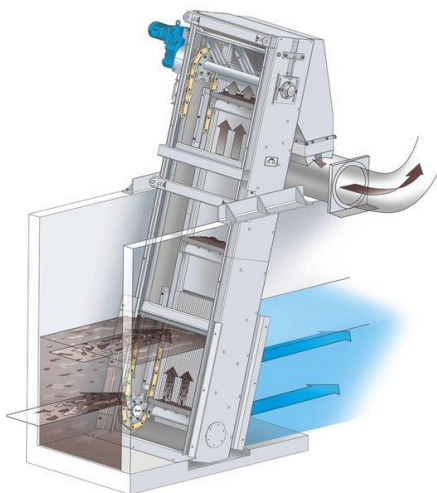

B. Grit Chamber

Where subsequent treatment technologies could be hindered or damaged by the presence of sand, grit chambers (or sand traps) allow for the removal of heavy inorganic fractions by settling. There are three general types of grit chambers: horizontal-flow, aerated, or vortex chambers. All of these designs allow heavy grit particles to settle out, while lighter, principally organic particles remain in suspension.

Figure 62: Schematic diagram of grit chamber

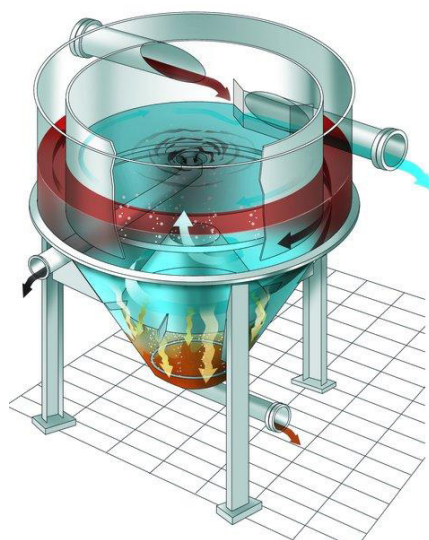

Secondary Treatment

A. Biogas Settlers

Biogas settlers are often used as a primary settling treatment and function much like septic tanks, with the difference that biogas is recovered. Wastewater and organic wastes are introduced in an airtight reactor, solids settle to the bottom, where they are decomposed by anaerobic digestion and transformed into biogas and fertilising slurry. The supernatant flows to further treatment steps or the storage tank to be reused for irrigation.

Figure 63: Schematic diagram of Biogas Settler

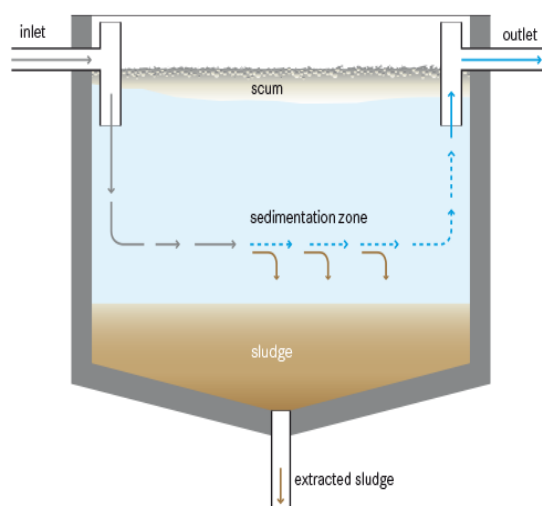

Source: Tilley et al. 2014

Table 13: Technical Details of Biogas Settlers

Working Principle	Biogas settlers are often used as a primary settling treatment and function much like septic tanks, with the difference that biogas is recovered. Wastewater and organic wastes are introduced in an airtight reactor, solids settle to the bottom, where they are decomposed by anaerobic digestion and transformed to biogas and fertilising slurry. The supernatant flows to further treatment steps or the storage tank to be reused for irrigation.
Capacity/Adequacy	Biogas settlers are most suited for decentralised wastewater treatment systems at household, community or institutional level. They are applicable in both urban and rural areas as long as the wastewater contains sufficient organic matter and is biodegradable.
Performance	80 to 85 % BOD; Relatively high pathogen removal; N and P remain in the sludge; HRT of some days; SRT of several years
Costs	Low capital and low operating costs
Self-help Compatibility	Expert design is required and the construction needs to be supervised; operation staff needs to receive training to understand the functioning. Can be constructed with locally available material.
O&M	Desludging every 2 to 5 years; Checking for gas-tightness should be done regularly.
Reliability	Resistant to shock loading. Reliable if operated and maintained well.
Main strength	High removal of organic pollutants without any requirement for energy; Generation of biogas and fertiliser (compost).
Main weakness	Expert design is required; The organic and solid content in the influent needs to be monitored.

3. Secondary Treatment

A. Anaerobic Baffle Reactor

An anaerobic baffled reactor (ABR) is an improved Septic Tank with a series of baffles under which the wastewater is forced to flow. The increased contact time with the active biomass (sludge) results in improved treatment. The upflow chambers provide enhanced removal and digestion of organic matter. BOD may be reduced by up to 90%, which is far superior to its removal in a conventional Septic Tank.

Figure 64: Schematic diagram of Anaerobic baffled reactor

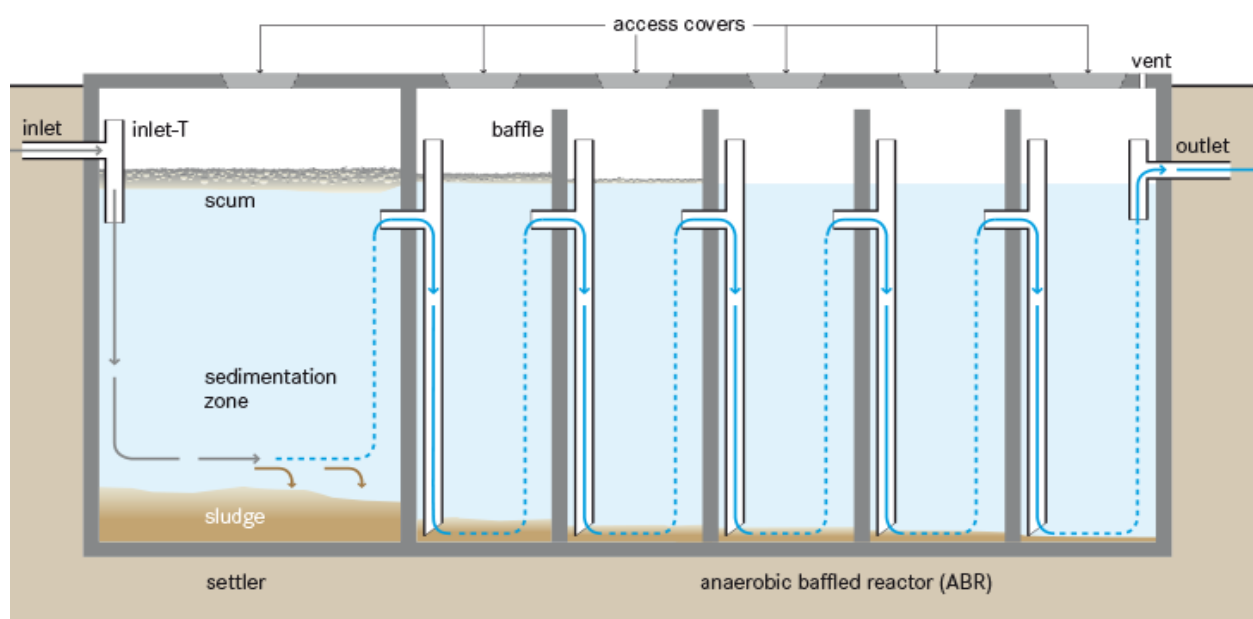

Source: Tilley et al. 2014

Table :14 Technical Details of Anaerobic Baffle Reactor

Working Principle	Vertical baffles in the tank force the pre-settled wastewater to flow under and over the baffles guaranteeing contact between wastewater and resident sludge and allowing an enhanced anaerobic digestion of suspended and dissolved solids; at least 1 sedimentation chamber and 2–5 up-flow chambers.
Capacity/Adequacy	Community (and household) level; For pre-settled domestic or (high-strength) industrial wastewater of narrow COD/BOD ration. Typically integrated in DEWATS systems; Not adapted for areas with high ground-water table or prone to flooding.
Performance	70- 95% BOD; 80% - 90% TSS; Low pathogen reduction. HRT: 1 to 3 days
Costs	Generally low-cost; depending on availability of materials and economy of scale.
Self-help Compatibility	Requires expert design but can be constructed with locally available material.
O&M	Should be checked for water tightness, scum and sludge levels regularly; Sludge needs to be dug out and discharged properly (e.g. in composting or drying bed); needs to be vented.
Reliability	High resistance to shock loading and changing temperature, pH or chemical composition of the influent; requires no energy.
Main strengths	Strong resistance; built from local material; biogas can be recovered.
Main weakness	Long start-up phase.

B. Anaerobic Filter

An anaerobic filter is a fixed-bed biological reactor with one or more filtration chambers in series. As wastewater flows through the filter, particles are trapped and organic matter is degraded by the active biomass that is attached to the surface of the filter material. An anaerobic filter is a fixed-bed biological reactor with one or more filtration chambers in series. As wastewater flows through the filter, particles are trapped and organic matter is degraded by the active biomass that is attached to the surface of the filter material.

Figure 65: Schematic diagram of anaerobic upflow filter

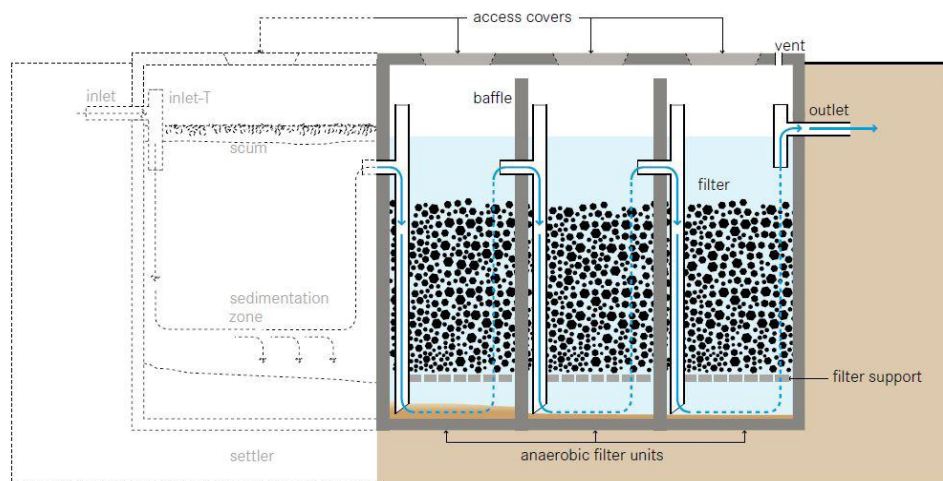

Source: Tilley et al. 2014)

Table :15 Technical Details of Anaerobic Upflow Filter

Working Principle	Dissolved and non-settleable solids are removed by anaerobic digestion through close contact with bacteria attached to the filter media
Capacity/Adequacy	Household and community level ;as secondary treatment step after primary treatment in a septic tank or an anaerobic baffled reactor ;effluents can be infiltrated into soil or reused for irrigation ;not adapted if high ground-water table or in areas prone to flooding.
Performance	BOD 50 :to ;90% TSS 50 :to ;% 80 Total Coliforms 1 :to 2 log units .HRT :about 1 day
Costs	Generally low-cost ;depending on availability of materials and frequency of back flushing and desludging.
Self-help Compatibility	Requires expert design but can be constructed with locally available material.
O&M	Regularly backflush to prevent clogging) without washing out the biofilm ;(desludging of the primary settling chambers ;needs to be vented if biogas not recovered.
Reliability	Reliable if construction is watertight and influent is primary settled ;Generally good resistance to shock loading.
Main strength	Resistant to shock loading ;High reduction of BOD and TSS.
Main weakness	Long start-up phase.

C. Up flow Anaerobic Sludge Blanket) UASB (Reactor

The up flow anaerobic sludge blanket reactor (UASB) is a single tank process. Wastewater enters the reactor from the bottom and flows upward. A suspended sludge blanket filters and treats the wastewater as the wastewater flows through it. The sludge blanket is comprised of microbial

granules (1 to 3 mm in diameter), i.e., small agglomerations of microorganisms that, because of their weight, resist being washed out in the upflow. The microorganisms in the sludge layer degrade organic compounds. As a result, gases (methane and carbon dioxide) are released. The rising bubbles mix the sludge without the assistance of any mechanical parts. Sloped walls deflect material that reaches the top of the tank downwards. The clarified effluent is extracted from the top of the tank in an area above the sloped walls. After several weeks of use, larger granules of sludge form which, in turn, act as filters for smaller particles as the effluent rises through the cushion of sludge. Because of the Upflow regime, granule-forming organisms are preferentially accumulated as the others are washed out.

Figure 66: Schematic diagram of UASB reactor

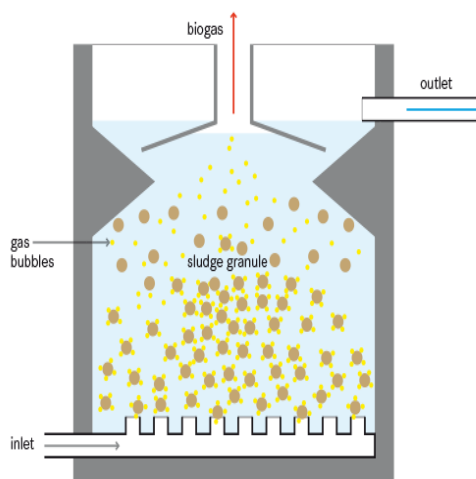

Source: Tilley et al. 2014

Table :16 Technical Details of UASB Reactor

Working Principle	Industrial wastewater or blackwater flows into the bottom of an anaerobic Up flow tank. Accumulated sludge forms granules. Microorganisms living in the granules degrade organic pollutants by anaerobic digestion. The sludge blanket is kept in suspension by the flow regime and formed gas bubbles. A separator at the top of the reactor allows to recover biogas for energy production, nutrient effluent for agriculture and to retain the sludge in the reactor. Sludge accumulation is low (emptying is only required every few years) and the sludge is stabilised and can be used as soil fertiliser.
Capacity/Adequacy	Centralised or decentralized at community level, for industrial wastewater or blackwater. The system requires a continuous and stable water flow and energy.
Performance	60 to 90 % BOD; 60 to 80 % COD and 60 to 85 % TSS; low pathogen reduction minimal removal of nutrient (N and P) HRT: minimal 2 hours, generally 4 to 20 hours
Costs	Investment is comparable to baffled reactors. For operation usually, no costs arise beneath desludging costs and operation of feeding pump.
Self-help Compatibility	Can be constructed with locally available material but requires skilled staff for construction, maintenance and operation.
O&M	Desludging is not frequent but feeder pump and control of organic loads requires skilled staff for operation and maintenance.
Reliability	Not resistant to shock loading and sensitive to organic load fluctuations.
Main strength	High removal of organics and solids (BOD and TSS) with low production of sludge and the possibility to recover biogas; only little land required.
Main weakness	Requires skilled staff, electricity and is sensitive to variable flows.

D. Constructed Wetlands) Horizontal Flow

A horizontal subsurface flow constructed wetland is a large gravel and sand-filled basin that is planted with wetland vegetation. As wastewater flows horizontally through the basin, the filter material filters out particles and microorganisms degrade the organics. The filter media acts as a filter for removing solids, a fixed surface upon which bacteria can attach, and a base for the vegetation. Although facultative and anaerobic bacteria degrade most organics, the vegetation transfers a small amount of oxygen to the root zone so that aerobic bacteria can colonize the area and degrade organics as well. Plant roots play an important role in maintaining the permeability of the filter.

Figure 67: Schematic diagram of horizontal flow constructed wetlands

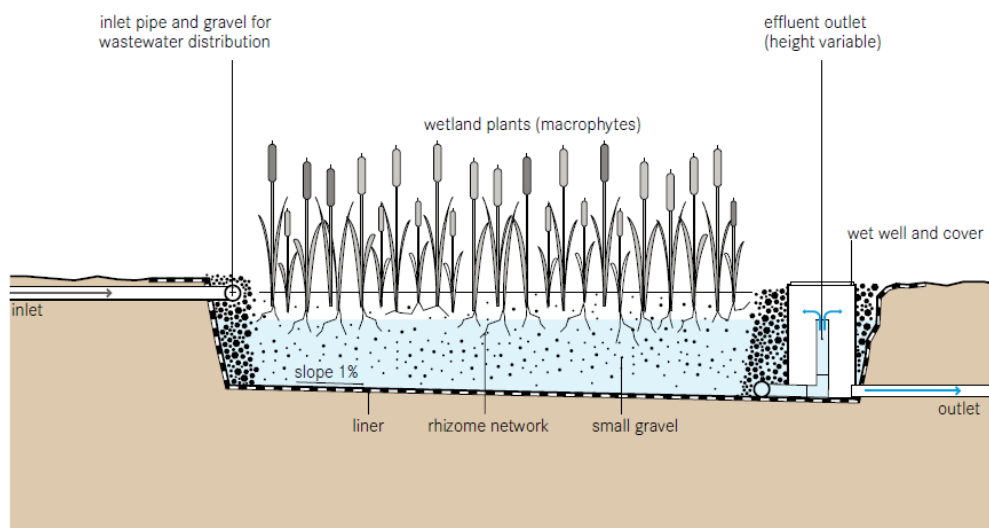

Source: Tilley et al. 2014

Table 17: Technical Details of Horizontal Flow Constructed Wetlands

Working Principle	Pre-treated grey or blackwater flows continuously and horizontally through a planted filter bed. Plants provide appropriate environments for microbiological attachment, growths and transfer of oxygen to the root zone. Organic matter and suspended solids are removed by filtration and microbiological degradation in aerobic anoxic and anaerobic conditions (MOREL and DIENER 2006).
Capacity/Adequacy	It can be applied for single households or small communities as a secondary or tertiary treatment facility of grey- or blackwater. Effluent can be reused for irrigation or is discharged into surface water (MOREL and DIENER 2006).
Performance	BOD = 80 to 90 %; TSS = 80 to 95 %; TN = 15 to 40 %; TP = 30 to 45 %; FC ≤ 2 to 3 Log; LAS > 90 %
Costs	The capital costs of constructed wetlands are dependent on the costs of sand and gravel and also on the cost of land required for the CW. The operation and maintenance costs are very low (MOREL and DIENER 2006).
Self-help Compatibility	O&M by trained labourers, most of construction material locally available, except filter substrate could be a problem. Construction needs expert design.
O&M	Emptying of pre-settled sludge, removal of unwanted vegetation, cleaning of inlet/outlet systems.
Reliability	Clogging of the filter bed is the main risk of this system, but treatment performance is satisfactory.
Main strength	Efficient removal of suspended and dissolved organic matter, nutrients and pathogens; no wastewater above ground level and therefore no odour nuisance; plants have a landscaping and ornamental purpose (MOREL and DIENER 2006).
Main weakness	Permanent space required; risk of clogging if wastewater is not well pre-treated, high quality filter material is not always available and expensive; expertise required for design, construction and monitoring (MOREL and DIENER 2006).

E. Constructed Wetlands (Vertical Flow)

A vertical flow constructed wetland is a planted filter bed that is drained at the bottom. Wastewater is poured or dosed onto the surface from above using a mechanical dosing system. The water flows vertically down through the filter matrix to the bottom of the basin where it is collected in a drainage pipe. The important difference between a vertical and horizontal wetland is not simply the direction of the flow path, but rather the aerobic conditions. By intermittently dosing the wetland (4 to 10 times a day), the filter goes through stages of being saturated and unsaturated, and, accordingly, different phases of aerobic and anaerobic conditions. During a flush phase, the wastewater percolates down through the unsaturated bed. As the bed drains, air is drawn into it and the oxygen has time to diffuse through the porous media. The filter media acts as a filter for removing solids, a fixed surface upon which bacteria can attach and a base for the vegetation. The top layer is planted and the vegetation is allowed to develop deep, wide roots, which permeate the filter media. The vegetation transfers a small amount of oxygen to the root zone so that aerobic bacteria can colonize the area and degrade organics. However, the primary role of vegetation is to maintain permeability in the filter and provide habitat for microorganisms. Nutrients and organic material are absorbed and degraded by the dense microbial populations. By forcing the organisms into a starvation phase between dosing phases, excessive biomass growth can be decreased and porosity increased.

Figure 68: Schematic diagram of vertical flow constructed wetlands

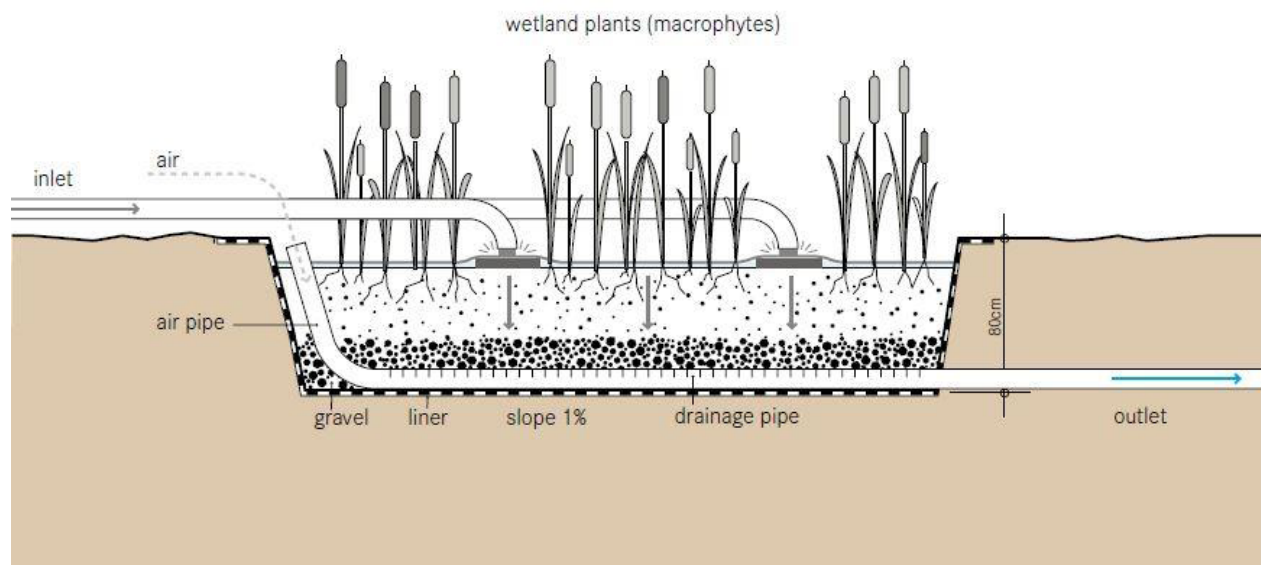

Source: Tilley et al. 2014)

Table :18 Technical Details of Vertical Flow Constructed Wetlands

Working Principle	Pre-treated grey- or blackwater is applied intermittently to a planted filter surface, percolates through the unsaturated filter substrate where physical, biological and chemical processes purify the water. The treated wastewater is collected in a drainage network (adapted from MOREL and DIENER 2006).
Capacity/Adequacy	It can be applied for single households or small communities as a secondary or tertiary treatment facility of grey- or blackwater. Effluent can be reused for irrigation or is discharged into surface water (MOREL and DIENER 2006).
Performance	BOD = 75 to 90%; TSS = 65 to 85%; TN < 60%; TP < 35%; FC ≤ 2 to 3 log; MBAS ~ 90%; (adapted from: MOREL & DIENER 2006)
Costs	The capital costs of constructed wetlands are dependent on the costs of sand and gravel and also on the cost of land required for the CW. The operation and maintenance costs are very low (MOREL and DIENER 2006).
Self-help Compatibility	O&M by trained labourers, most of construction material locally available, except filter substrate could be a problem. Construction needs expert design. Electricity pumps may be necessary.
O&M	Emptying of pre-settled sludge, removal of unwanted vegetation, cleaning of inlet/ outlet systems.
Reliability	Clogging of the filter bed is the main risk of this system, but treatment performance is satisfactory.
Main strength	Efficient removal of suspended and dissolved organic matter, nutrients and pathogens; no wastewater above ground level and therefore no odour nuisance; plants have a landscaping and ornamental purpose (MOREL and DIENER 2006).
Main weakness	Even distribution on a filter bed requires a well-functioning pressure distribution with pump or siphon. Uneven distribution causes clogging zones and plug flows with reduced treatment performance; high quality filter material is not always available and expensive; expertise required for design, construction and monitoring (MOREL and DIENER 2006).

F. Activated Sludge Process

An activated sludge process refers to a multi-chamber reactor unit that makes use of highly concentrated microorganisms to degrade organics and remove nutrients from wastewater to produce a high-quality effluent. To maintain aerobic conditions and to keep the activated sludge suspended, a continuous and well-timed supply of oxygen is required.

Different configurations of the activated sludge process can be employed to ensure that the wastewater is mixed and aerated in an aeration tank. Aeration and mixing can be provided by pumping air or oxygen into the tank or by using surface aerators. The microorganisms oxidize the organic carbon in the wastewater to produce new cells, carbon dioxide and water. Although aerobic bacteria are the most common organisms, facultative bacteria along with higher organisms can be present. The exact composition depends on the reactor design, environment, and wastewater characteristics.

The flocs (agglomerations of sludge particles), which form in the aerated tank, can be removed in the secondary clarifier by gravity settling. Some of this sludge is recycled from the clarifier back to the reactor. The effluent can be discharged or treated in a tertiary treatment facility if necessary, for further use.

Activated sludge processes are one part of a complex treatment system. They are usually used after primary treatment (that removes settleable solids) and are sometimes followed by a final

polishing step (see POST, p.136). The biological processes that occur are effective at removing soluble, colloidal and particulate materials. The reactor can be designed for biological nitrification and denitrification, as well as for biological phosphorus removal. The design must be based on an accurate estimation of the wastewater composition and volume. Treatment efficiency can be severely compromised if the plant is under- or over-dimensioned. Depending on the temperature, the solids retention time (SRT) in the reactor ranges from 3 to 5 days for BOD removal, to 3 to 18 days for nitrification. The excess sludge requires treatment to reduce its water and organic content and to obtain a stabilized product suitable for end-use or final disposal. It is important to consider this step in the planning phase of the treatment plant.

Figure 69: Schematic diagram of activated sludge process

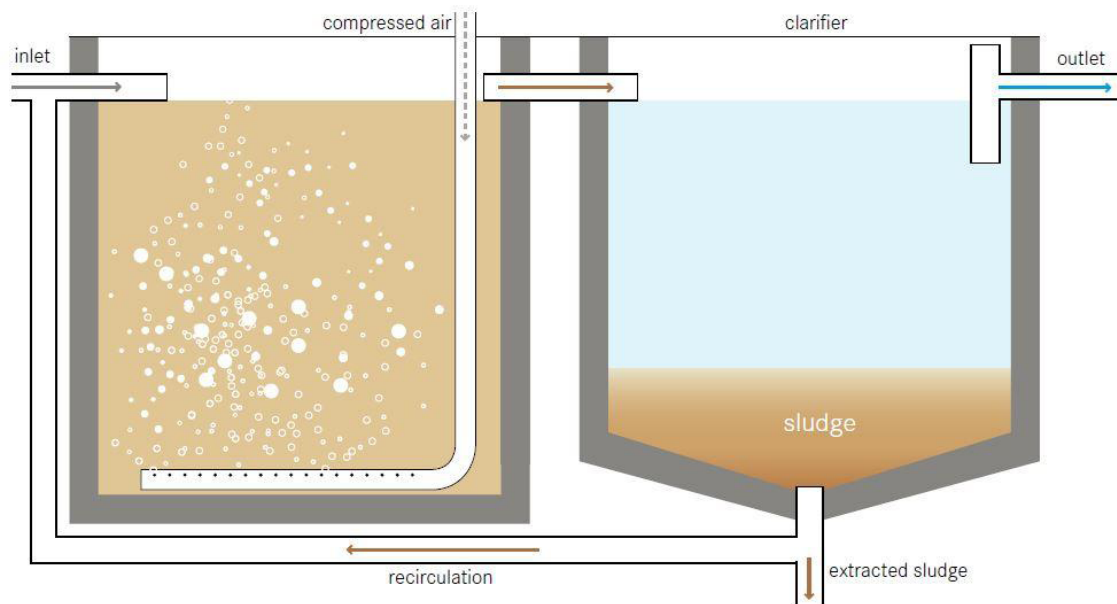

Source: Tilley et al. 2014

G. Sequential Batch Reactor (SBR)

The Sequencing Batch Reactor (SBR) is a different configuration of the conventional activated sludge systems, in which the process can be operated in batches, where the different conditions are all achieved in the same reactor but at different times. The treatment consists of a cycle of five stages: fill, react, settle, draw and idle. During the reaction type, oxygen is added by an aeration system. During this phase, bacteria oxidise the organic matter just as in activated sludge systems. Thereafter, aeration is stopped to allow the sludge to settle. In the next step, the water and sludge are separated by decantation and the clear layer (supernatant) is discharged from the reaction chamber (ASANO et al. 2007). Depending on the rate of sludge production, some sludge may also be purged. After a phase of idle, the tank is filled with a new batch of wastewater (UNEP and MURDOCH UNIVERSITY 2004). At least two tanks are needed for the batch mode of operation as continuous influent needs to be stored during the operation phase. Small systems may apply only one tank. In this case, the influent must either be retained in a pond or continuously discharged to the bottom of the tank in order not to disturb the settling, draw and idle phases. SBRs are suited to lower flows, because the size of each tank is determined by the volume of wastewater produced during the treatment period in the other tank (UNEP and MURDOCH UNIVERSITY 2004). Pollutants removal efficiency: BOD5: 95%, COD: 90%, TSS: 95%, Pathogen: N/A.

Figure 70: Process diagram of SBR

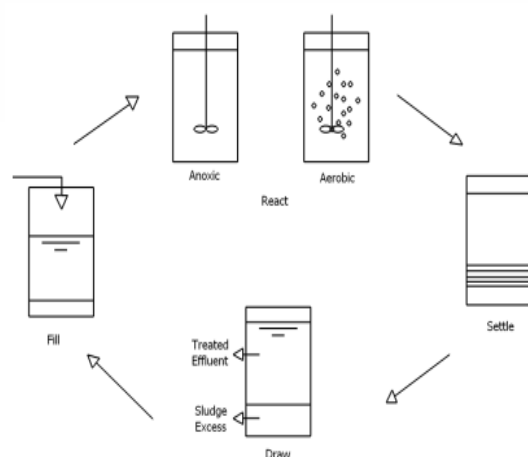

H. Moving Bed Bio Reactor (MBBR)

MBBR is a highly effective biological treatment process based on a combination of conventional activated sludge process and biofilm media. The MBBR process utilizes floating media within the aeration and anoxic tanks. The microorganisms consume organic material. The media provides increased surface area for the biological microorganisms to attach and grow. The increased surface area reduces the footprint of the tanks required to treat the wastewater. The treatment process can be aerobic and/or anaerobic and operates at high volume loads.

Figure 71: Schematic Diagram of Moving Bed Bio Reactor

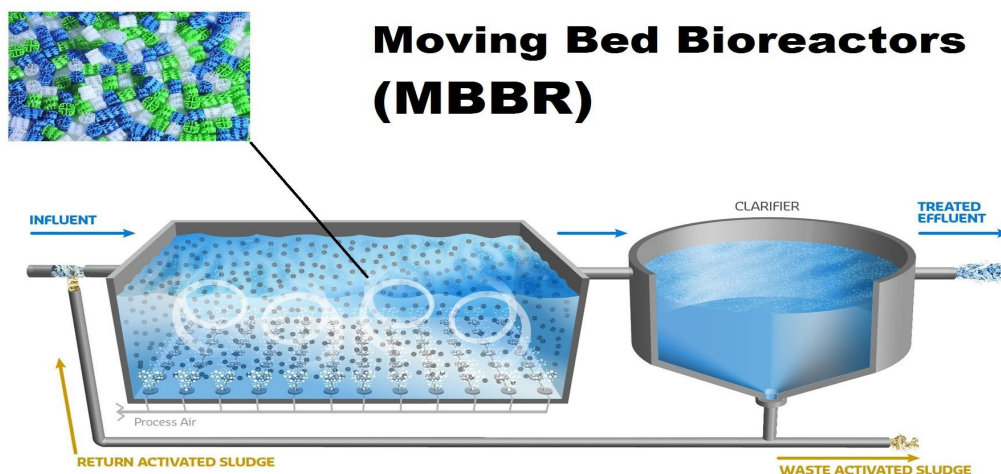

Source: HCR Ventures

MBBR units are placed in series based on the load entering each reactor. Neutralised and settled wastewater passes through MBBR for reduction in BOD/COD. Most of the MBBR plants are provided with vertically or horizontally mounted rectangular mesh sieves or cylindrical bar sieves. Biofilm carriers are made up of high density (0.95 g/cm³) polyethylene. These are normally shaped as small cylinders with a cross inside and fins outside. The standard filling of carrier is below 70% with a maximum specific area not more than 465 m²/m³. Generally, design load for COD-BOD removal is 20 g COD / m²d. Smaller carriers need smaller reactor volume at a given loading rate (as g/m²d) when the carrier filling is same. HRT of the reactor is about 3 – 4 hours for effective BOD and nitrogen removal. It is advisable to use MBBR in combination with a septic tank or a pre-coagulation step as a pre-treatment unit, depending on the local conditions and input characteristics. It is a very robust and compact alternative for secondary treatment of municipal wastewater, having removal efficiency for BOD 90 – 95% (low rate) and that of 75 – 80% for high rate. Average nitrogen removal is about 85%.

I. Membrane BioReactor (MBR)

Figure 72: Schematic diagram of MBR

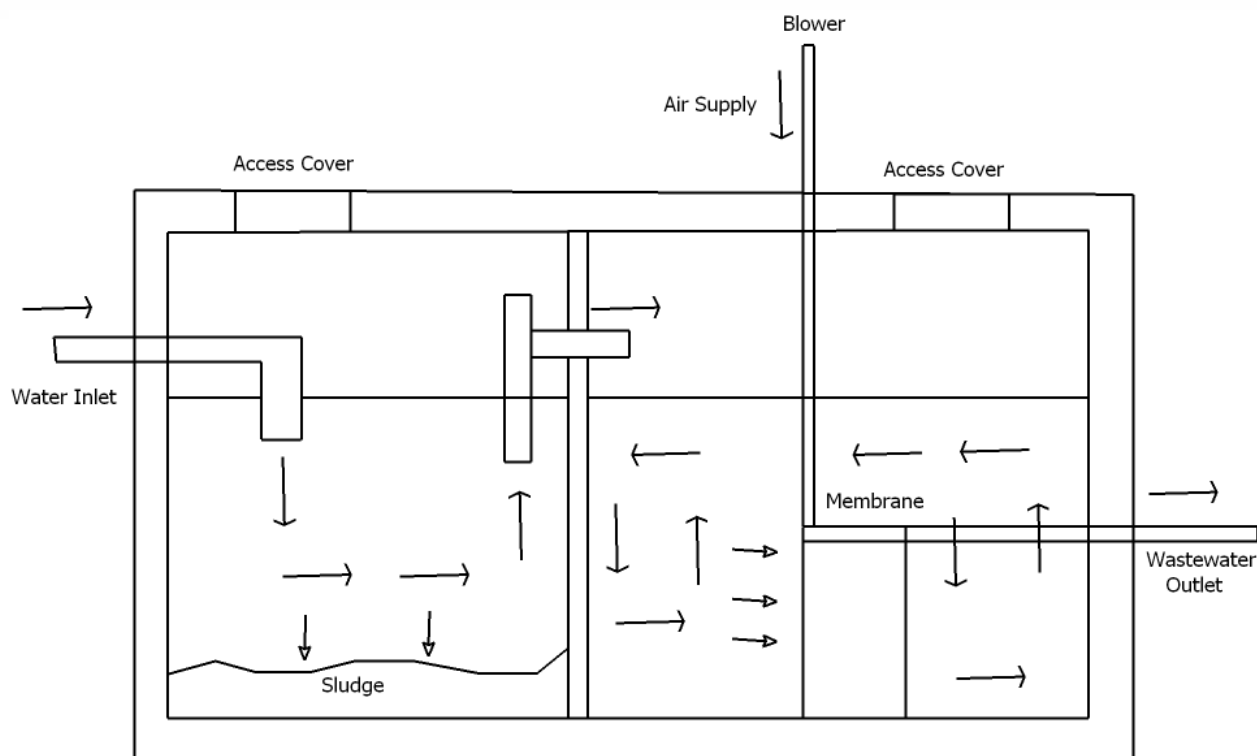

The Membrane Bioreactor (MBR) process (membrane activated sludge process) is an advanced wastewater treatment technology and constitutes a suspended growth activated sludge system, which instead of secondary clarifiers utilises low-pressure membranes for solid/liquid separation. As opposed to secondary clarification, the quality of solids separation is not dependent upon the mixed liquor suspended solids concentration, or the settling characteristic. Hence, the fact that MBRs can operate with much higher mixed liquor suspended solid concentrations, which provides an intensified biological process. Accordingly, the two major benefits of the MBR process are substantially reduced land and space requirements, and the reclamation of water (permeate) of excellent quality, which is a valuable source for higher demand reuse applications (LAHNSTEINER et al. 2007). There are five types of membrane configuration, which are currently in operation: Hollow fibre (HF), Spiral-wound, Plate-and-frame (i.e. flat sheet - FS), Pleated filter cartridge and Tubular. To provide optimal aeration and scour around the membranes, the mixed liquor is typically kept in the 1.0-1.2% solids range, which is 4 times that of a conventional plant. Pollutants removal efficiency: BOD₅: 99%, COD: 95%, TSS: 99%, Pathogen: 99.99% (FITZGERALD 2008).

Table :19 Technical Details of MBR

Working Principle	Membrane Bioreactors (MBRs) combine conventional biological treatment (e.g. activated sludge) processes with membrane filtration to provide an advanced level of organic and suspended solids removal.
Capacity/Adequacy	Applicable in conventional wastewater plants.
Performance	High
Costs	High capital and operational costs.
Self-help Compatibility	Low
O&M	Membranes need to be cleaned regularly.
Reliability	High if membranes are maintained correctly.
Main strength	Secondary clarifiers and tertiary filtration processes are eliminated, thereby reducing plant footprint.
Main weakness	High operation and capital costs (membranes).

4. Tertiary Treatment

A. Chlorination

The destruction, inactivation, or removal of pathogenic microorganisms can be achieved by chemical, physical, or biological means. Due to its low cost, high availability and easy operation, chlorine has historically been the disinfectant of choice for treating wastewater.

Chlorine oxidizes organic matter, including microorganisms and pathogens. Concerns about harmful disinfection by-products (DBP) and chemical safety, however, have increasingly led to chlorination being replaced by alternative disinfection systems, such as (UV) radiation and ozonation (O3).

Figure 73: Chlorination basin and schematic diagram of chlorine dosing and mixer

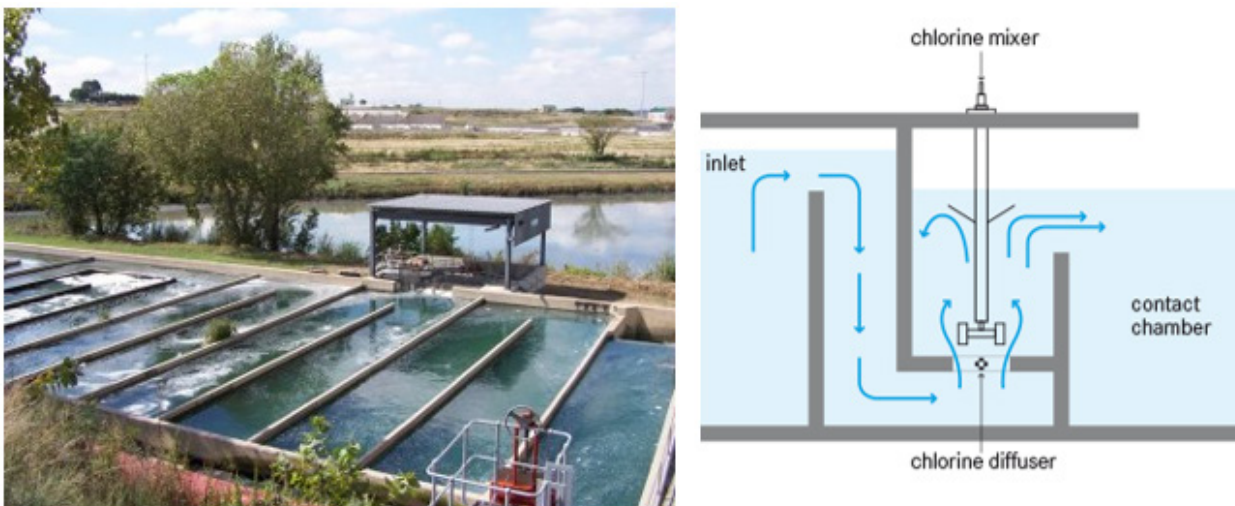

B. Ozonation

Ozonation is an efficient treatment to reduce the amounts of micropollutants released in the aquatic systems by wastewater treatment plants (MARGOT et al. 2011). Although no residual by-products are generated by ozone itself, some concerns are raised regarding oxidation by-products when water containing both organics and ions, such as bromide, iodide and chlorine ions, are treated with ozonation. A typical ozonation system consists of an ozone generator and a reactor where ozone is bubbled into the water to be treated.

Figure 74: Schematic diagram of ozonation

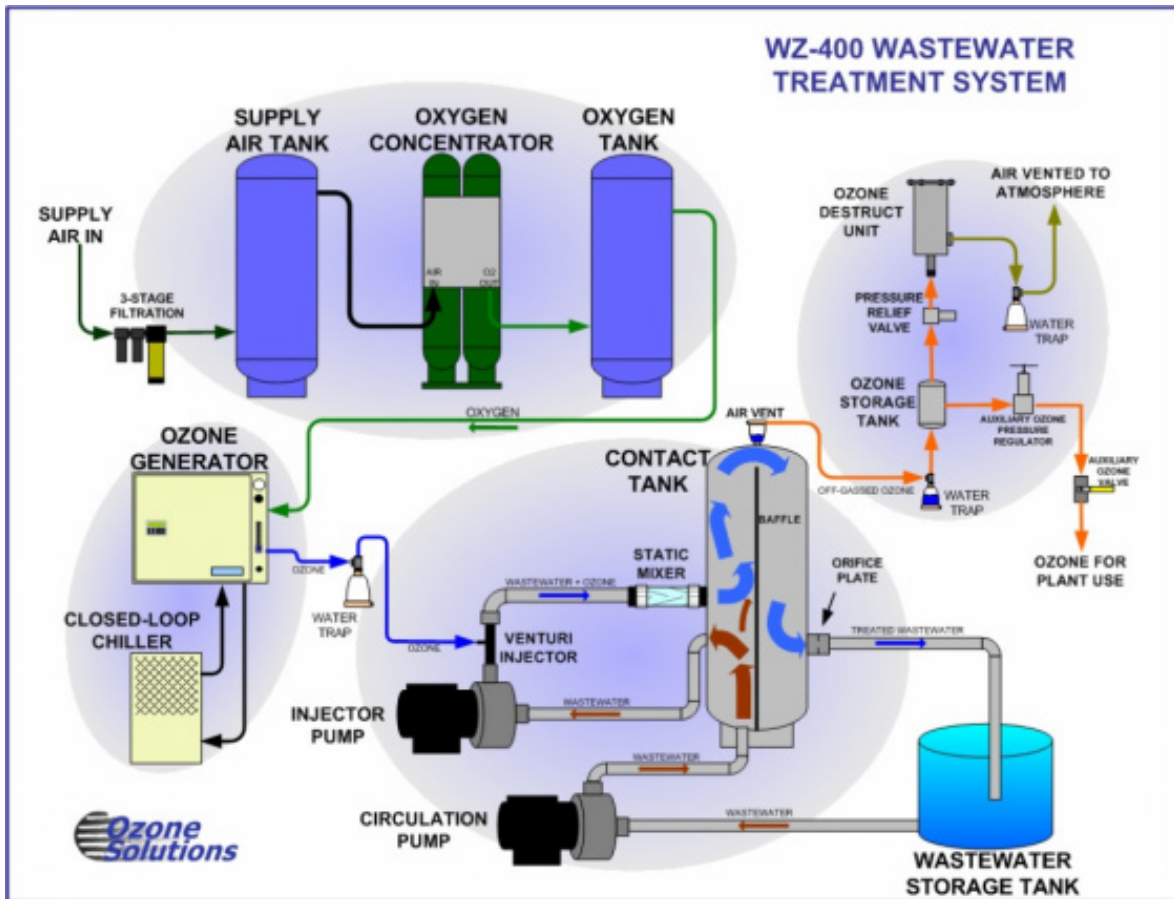

(Source: Ozone solutions)

Table :20 Technical Details of Ozonation

Working Principle	Infusion of ozone, a gas produced by subjecting oxygen molecules to high electrical voltage, which reacts with microorganisms and pollutants
Capacity/Adequacy	High tech equipment required
Performance	High efficiency
Costs	Relatively high operation costs
Self-help Compatibility	Engineers are required for the design
O&M	Continuous input of electrical power required
Reliability	Reliable if operating conditions are scaled taking into account wastewater content
Main strength	Very efficient and fast method for disinfection and as a AOP
Main weakness	Requires complicated equipment as well as large amounts of energy and qualified operators

5. Treatment Chain

To design the system for the statement given by the facilitator .Under the suitability of the treatment system for the defined scenario .There are few examples are given below for the reference.

Case I: ASP

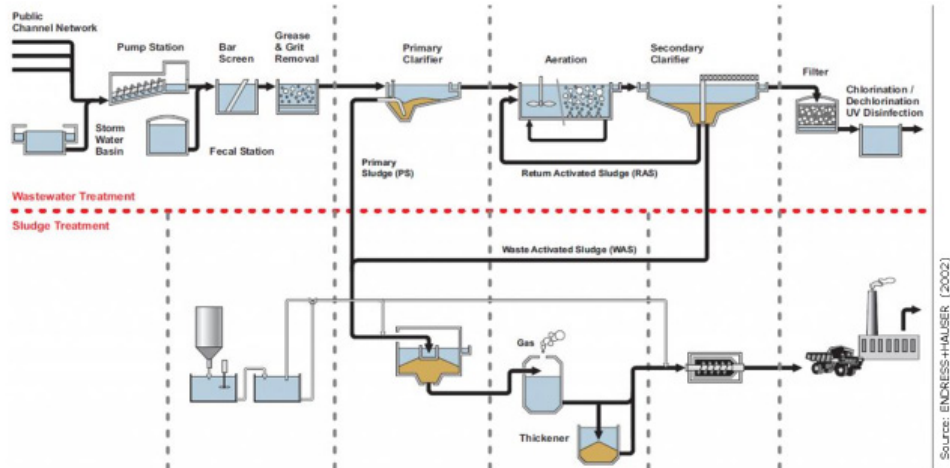

Case II: Trickling filter

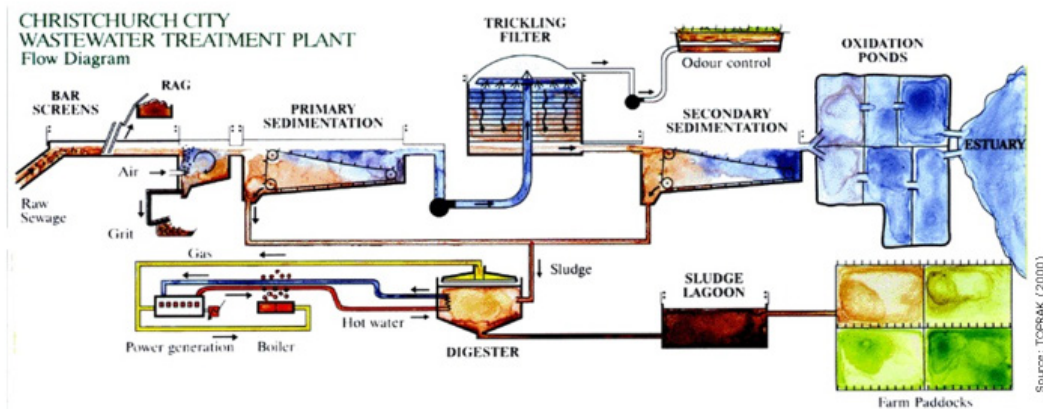

Case III: DTS

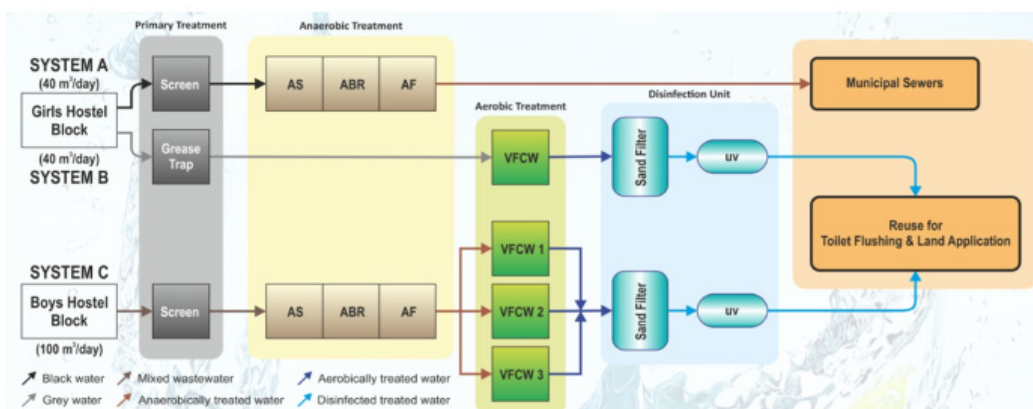

5. Notes for trainer

This session does not contain any group activity; however, it is recommended to have a discussion with the participants on basics of wastewater treatment and its processes. It will help in understanding the treatment of liquid effluent at the FSTP.

6. Bibliography

1. TILLEY, E.; ULRICH, L.; LUETHI, C.; REYMOND, P.; ZURBRUEGG, C. (2014): Compendium of Sanitation Systems and Technologies. 2nd Revised Edition. Duebendorf, Switzerland: Swiss Federal Institute of Aquatic Science and Technology (Eawag). URL
2. TILLEY, E.; ULRICH, L.; LUETHI, C.; REYMOND, P.; ZURBRUEGG, C. (2014): Compendium of Sanitation Systems and Technologies. Technology Cards for Workshops. Duebendorf, Switzerland: Swiss Federal Institute of Aquatic Science and Technology (Eawag). URL
3. CONRADIN, K. (Editor); KROPAC, M. (Editor); SPUHLER, D. (Editor) (2010): SSWM Toolbox. Sustainable Sanitation and Water Management Toolbox. Basel: seecon international gmbh. URL
4. ROBBINS, D.M.; LIGON, G.C. (2014): How to Design Wastewater Systems for Local Conditions in Developing Countries. London: International Water Association (IWA). URL
5. CPHEEO, GoI (2013): Manual on Sewerage and Sewage Treatment Systems, Part A: Engineering, 3rd Edition, Ministry of urban Development, Government of India. <http://cpheeo.nic.in/Sewerage.aspx>
6. ROBBINS, D.M.; LIGON, G.C. (2014): How to Design Wastewater Systems for Local Conditions in Developing Countries. London: International Water Association (IWA). URL
7. CONRADIN, K. (Editor); KROPAC, M. (Editor); SPUHLER, D. (Editor) (2010): SSWM Toolbox. Sustainable Sanitation and Water Management Toolbox. Basel: seecon international gmbh. URL

Session

21

Financial Aspects of Faecal Sludge & Septage Management

1. Session objectives

- To introduce the participants to financial aspects involved in installation of treatment facility.
- To introduce to the participants various financial transfers and financial and contracting models for operationalizing FSSM.

2. Session plan

Duration- 45 minutes

Activity	Time	Material/Method
Financial aspects	15 min	Powerpoint presentation
Financial transfers	15 min	Powerpoint presentation
Financial flow models	15 min	Powerpoint presentation and discussions
Exercise	45 min	Group exercise from Workbook

3. Key facts

- There are multiple types of cost which need to be considered by setting up a FSTP.
- Selection of the technologies should be done after looking at LCC of the project.
- There are multiple transfers which happen when FSSM is operationalized understanding each one of them helps to choose appropriate financial and contracting model.
- Selecting appropriate contracting and financial transfer model is key to have successful PPP and sustainability of the FSSM.

4. Learning notes

1. Financial aspects

Capital expenditure

CAPEX of the project refers to all the expenditures which will happen only once for setting up or implementation of the project. Following are few examples of capital expenditures;

1. Cost of land and site preparation
2. Civil structures, electrical and plumbing components, electromechanical components
3. Establishment cost
4. Site investigation
5. Transport and overhead.

Operational expenditure

OPEX can be classified into (1) direct costs and (2) indirect costs.

Direct costs refer to the expenditure which variable and depend on the degree or hours of operations. Ex. Cost of electrical energy, cost of polymers (coagulants).

Indirect cost refers to the expenditure which is fixed and does not depend on other factors such as load of FSS received etc. Ex. Lease of the land, human resource cost.

Income and revenue

Income and revenue refer to the incoming monetary streams. In case of FSTP, revenue can be generated through, (a) discharge fees, (b) purchase fees and (c) budget support.

Life cycle cost analysis

LCA refers to the process which account the CAPEX, OPEX and revenues over the life period of the project and gives a single cost. Depending upon the type of analysis used, the ultimate derived cost is known as annualized cost or net present value etc.

It is recommended to compare the LCC of project to choose suitable technologies for treatment of FSS. The non-mechanized (natural treatment) components for treatment of FSS require larger area and typically have more CAPEX as compared to mechanized components. However, the OPEX of the non-mechanized component might be lesser as compared to mechanized component. Hence LCC gives a much more holistic picture of the cost of treatment.

LCC also gives an opportunity to check the financial viability of the treatment of FSS, as the cost of treatment needs to be covered by the end beneficiaries i.e. the households and/or ULB.

2. Financial transfer

There are various financial transfers which might happen when FSSM is operationalized in the ULB. Understanding of all types of financial transfers is needed in order to choose appropriate financial transfer model.

Following are the types of financial transfers which might happen;

1. Budget support
2. Capital investment
3. Discharge fee
4. Discharge incentive
5. Discharge license fee
6. Emptying fees
7. Fines
8. Operation and maintenance cost
9. Purchase price
10. Sanitation tax

3. Financial flow model

Financial flow model helps to identify the contracting model and inclusion of private companies in operations of FSSM. Following are the type of financial transfer models;

1. **Private model** – In a commonly occurring scenario, when an emptying activity is initiated by a private enterprise (mechanical or manual emptying), the households or customers with on-site sanitation systems can contact the private operator to provide emptying services on a fixed agreed tariff. Ideally, the private operator is required to transport and safely dispose the FS either to a treatment plant or to a designated disposal site, typically a landfill. In the first case, there is an FSTP which is constructed and managed by municipal authority or its on PPP model and private operator is transporting the FSS to the FSTP. In the second scenario, as there is no binding to private operator with municipal authority, they can opt the indiscriminate disposal of it on landfill site or water bodies or in open drains.
2. **Licensing model** – This model is similar to the commonly occurring private emptying and transportation model. The key difference lies in the issuing of license/permits to the private truck operators by relevant municipal authorities to operate emptying activity. Licensing helps in accounting for all emptying activity in the city, and can potentially track these operations to

prevent illegal disposal of FSS. The license/permit could be either a one-time fee or fees paid annually by the truck operators. The municipal authority issuing the license provides basic “dos and don’ts” to the truck operators, and they need to monitor for regulatory compliance by tracking the operations of private truck operators. The license is revoked, if the truck operator is found to be violating any regulations, especially engaging in the illegal disposal of FSS in non-designated sites.

3. **Sanitation tax model** – This model has two key aspects: a) sanitation tax collected from owners of OSSs, and b) mandatory scheduled desludging of tanks/pits. Sanitation tax is collected by the local municipal authority either as a percentage of property tax or by the public utilities as a surcharge on water bills. Local authorities in discussion with the households using OSSs set up a mandatory scheduled desludging plan. The user of the OSS does not pay for the desludging services unless they require an unscheduled service. The revenue generated from the sanitation tax is designed to cover the O&M cost of collection, transportation and treatment of FS. Local authorities can contract scheduled desludging to private truck operators to collect and transport sludge to designated disposal or treatment sites. The private entity receives payment based on the quantity of sludge delivered to the treatment plant (preventing illegal dumping) and the number of households that used the desludging service.
4. **Incentivized disposal model** – This model provides financial incentives to truck operators to encourage disposal of sludge at designated treatment sites. The objective of the model is to eliminate indiscriminate disposal of FS. The model does not charge disposal fees to truck operators to discharge FS at treatment sites, and instead the truck operators are paid a fixed price by the treatment plant for delivering FS.

5. Notes for trainer

This session is an exercise where the participants try to find a solution to the given scenario in the Workbook in the module. The calculations are based on the methodology described in “Decentralized Wastewater Treatment in Developing Countries” by Ludwig Sasse (1998). The calculations shown in the exercise is the basic calculation approach and shall be appropriately adopted to perform LCA in case to case basis.

6. Bibliography

1. STRANDE, L.; RONTELTAP, M.; BRDJANOVIC, D. (2014): Faecal Sludge Management - Systems Approach for Implementation and Operation. London: IWA Publishing URL
2. Ludwig Sasse (1998): DEWATS Decentralized Wastewater Treatment in Developing Countries, BORDA URL
3. Dodane, P.H., Mbéguéré, M., Ousmane, S., Strande, L. (2012). Capital and Operating Costs of Full-Scale Faecal Sludge Management and Wastewater Treatment Systems in Dakar, Senegal. *Environmental Science & Technology* 46 (7), p.3705-3711.
4. Robbins, D.M., Strande, L., Doczi, J. (2012). Sludge Management in Developing Countries: experiences from the Philippines. *Water* 21, Issue 4.
5. Steiner, M., Montangero, A. (2003). Towards More Sustainable Faecal Sludge Management Through Innovative Financing: Selected Money Flow Options. Dübendorf, Switzerland, Swiss Federal Institute of Aquatic Science and Technology.
6. Tilley, E., Lüthi, C., Morel, A., Zurbrügg, C., Schertenleib, R. (2008). Compendium of sanitation systems and technologies. Swiss Federal Institute of Aquatic Science and Technology (EAWAG), Dübendorf, Switzerland.
7. Rao, Krishna C.; Kvarnstrom, E.; Di Mario, L.; Drechsel, Pay. 2016. Business Models for Fecal Sludge Management. Colombo, Sri Lanka: International Water Management Institute (IWMI). CGIAR Research Program on Water, Land and Ecosystems (WLE). 80p. (Resource Recovery and Reuse Series 06) doi: 10.5337/2016.213

Download our latest reports, research briefs
and training modules at:

scbp.niua.org

About NIUA

NIUA is a premier national institute for research, capacity building and dissemination of knowledge in the urban sector, including sanitation. Established in 1976, it is the apex research body for the Ministry of Housing and Urban Affairs (MoHUA), Government of India. NIUA is also the strategic partner of the MoHUA in capacity building for providing single window services to the MoHUA/states/ULBs.

About SCBP

The Sanitation Capacity Building Platform (SCBP) is an initiative of the National Institute of Urban Affairs (NIUA) to address urban sanitation challenges in India. SCBP, supported by Bill & Melinda Gates Foundation (BMGF) is an organic and growing collaboration of credible national and international organisations, universities, training centres, resource centres, non-governmental organisations, academia, consultants and experts. SCBP supports national urban sanitation missions, states and ULBs, by developing and sourcing the best capacity building, policy guidance, technological, institutional, financial and behaviour change advise for FSSM. SCBP provides a unique opportunity for:

- Sharing and cross learning among the partner organisations, to pool in their knowledge resources on all aspects of urban sanitation capacity building;
- Developing training modules, learning and advocacy material including key messages and content, assessment reports and collating knowledge products on FSSM. Through its website (scbp.niua.org), SCBP is striving to create a resource centre on learning and advocacy materials, relevant government reports, policy documents and case studies;
- Dissemination of FSSM research, advocacy and outreach to State governments and ULBs.

Its strength is its ability to bring together partners to contribute towards developing state sanitation policy, training of trainers and training content development, technical and social assessments, training programme delivery, research and documentation.



National Institute of Urban Affairs

National Institute of Urban Affairs

1st Floor, Core 4B, India Habitat Centre, Lodhi Road, New Delhi - 110003

Phone: 011-24617517, 24617543, 24617595, Fax: 011-24617513

E-mail: niua@niua.org • Website: www.niua.org, scbp.niua.org

